

BRIGHT-TOOLS

BRIGHT-TOOLS

TOOL HOLDERS **CAT**

BRIGHT-TOOLS

BRIGHT-TOOLS

BRIGHT-TOOLS

BRIGHT-TOOLS

BRIGHT-TOOLS

BRIGHT-TOOLS

CAT Taper Standard CAT 锥柄标准

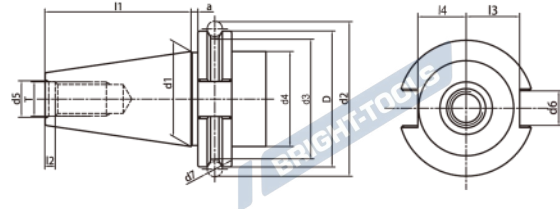
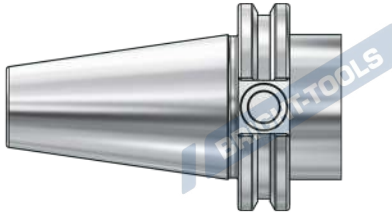

Size	D	d1	d2	d3	d4	d5	d6	d7	l1	l2	l3	l4	l5	T
CAT30	1.812	1.25	2.176	1.531	1.25	0.516	0.645	0.2813	1.875	0.188	0.735	0.64	0.44	1/2-13
CAT40	2.500	1.75	2.863	2.219	1.75	0.641	0.645	0.2813	2.687	0.188	0.985	0.89	0.44	5/8-11
CAT50	3.875	2.75	4.238	3.594	2.75	1.020	1.020	0.2813	4.000	0.250	1.485	1.39	0.44	1-8

Taper standard: ANSI B5.50
Material: Alloyed case hardened steel
Surface Treatment: Blackening and Bright
Taper tolerance: <AT3
Hardness: HRC 56-60
Carbon depth: 0.8±0.2mm
Surface Roughness: Ra<0.2µm
Balancing: G6.3/15000; G2.5/25000
Cooling: AD; AD/B can be made by request.

CAT TOOLING SYSTEM CAT 工具系统

ER Collet Chuck	F.04
ER弹簧夹头刀柄	
ER Collet Chuck,Short	F.04
ER弹簧夹头刀柄,超短型	
Power Milling Chuck.....	F.07
强力铣刀柄	
TG Collet Chuck.....	F.09
TG 超强力刀柄	
Face Mill Holder	F.10
面铣刀柄	
End Mill Holder.....	F.11
侧固刀柄	
Morse Taper Adapter	F.16
带扁尾莫氏刀柄	
Tool Holder Adatper Sleeve	F.16
转换刀柄	
Drill Chuck Adapter	F.17
钻接杆	
APU Drill Chuck Holder	F.17
APU钻夹头刀柄	
Precision Drill Chuck Holder	F.18
精密钻夹头刀柄	
Quick Change Tapping Chuck	F.18
弹性快换攻丝刀柄	
Screw-in Milling Cutter Holder.....	F.19
SOM 锁牙刀柄	
Runout Adjustable Flange Adapter.....	F.22
可调节精度法兰刀柄	
UM Adjustable	F.22
UM调零刀柄	
Boring Bar Blank	F.23
基础柄	
Test Arbor	F.23
主轴检测棒	
Alignment Tool for ATC Arm	F.24
调整机械用手用组合模具	



CAT

ER Collet Chuck with UM Nut

ER 弹簧夹头刀柄

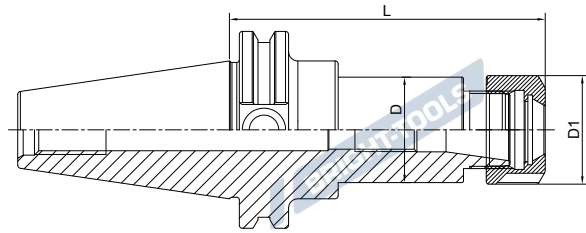
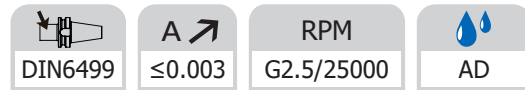

Size	D	D1	L	Capacity
CAT40-ER16UM-2.5"	28	32	2.5"	1-10
CAT40-ER20UM-2.5"	34	35	2.5"	1-13
CAT40-ER25-2.5"	42	42	2.5"	2-16
CAT40-ER32-2.5"	44.45	50	2.5"	2-20
CAT40-ER40-3"	50	63	3"	3-26
CAT40-ER16UM-4"	28	32	4"	1-10
CAT40-ER20UM-4"	34	35	4"	1-13
CAT40-ER25-4"	42	42	4"	2-16
CAT40-ER32-4"	44.45	50	4"	2-20
CAT40-ER40-4"	50	63	4"	3-26
CAT40-ER16UM-6"	28	32	6"	1-10
CAT40-ER20UM-6"	34	35	6"	1-13
CAT40-ER25-6"	42	42	6"	2-16
CAT40-ER32-6"	44.45	50	6"	2-20
CAT40-ER40-6"	50	63	6"	3-26
CAT40-ER16UM-8"	28	32	8"	1-10
CAT40-ER20UM-8"	34	35	8"	1-13
CAT40-ER25-8"	42	42	8"	2-16
CAT40-ER32-8"	44.45	50	8"	2-20
CAT40-ER40-8"	50	63	8"	3-26

CAT

ER Collet Chuck with UM Nut
ER 弹簧夹头刀柄

DIN6499	A ≤ 0.003	RPM G2.5/25000	AD
---------	----------------	-------------------	----

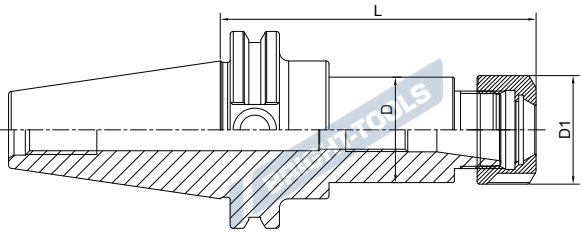

Size	D	D1	L	Capacity
CAT50-ER16UM-2"	28	32	2"	1-10
CAT50-ER20UM-2"	34	35	2"	1-13
CAT50-ER25-2"	32	42	2"	2-16
CAT50-ER32-2"	44.45	50	2"	2-20
CAT50-ER16UM-4"	28	32	4"	1-10
CAT50-ER20UM-4"	34	35	4"	1-13
CAT50-ER25-4"	42	42	4"	2-16
CAT50-ER32-4"	50	50	4"	2-20
CAT50-ER40-4"	63	63	4"	3-26
CAT50-ER50-4"	78	78	4"	6-34
CAT50-ER16UM-6"	28	32	6"	1-10
CAT50-ER20UM-6"	34	35	6"	1-13
CAT50-ER25-6"	42	42	6"	2-16
CAT50-ER32-6"	50	50	6"	2-20
CAT50-ER40-6"	63	63	6"	3-26
CAT50-ER16UM-8"	28	32	8"	1-10
CAT50-ER20UM-8"	34	35	8"	1-13
CAT50-ER25-8"	42	42	8"	2-16
CAT50-ER32-8"	50	50	8"	2-20
CAT50-ER40-8"	63	63	8"	3-26

CAT



ER Collet Chuck with Hex Nut

ER 弹簧夹头刀柄

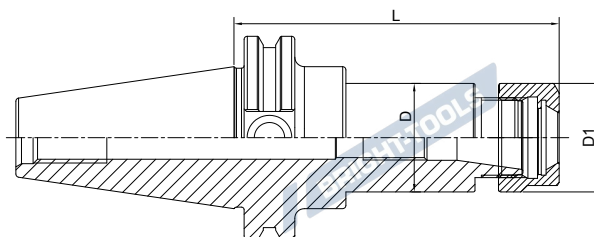
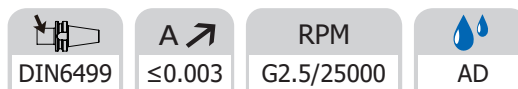

Size	D	D1	L	Capacity
CAT40-ER11-2.5"	19	19	2.5"	1-7
CAT40-ER16-2.5	44.45	28	2.5"	1-10
CAT40-ER20-2.5	34	34	2.5"	1-13
CAT40-ER11-4"	19	19	4"	1-7
CAT40-ER16-4"	28	28	4"	1-10
CAT40-ER20-4"	34	34	4"	1-13
CAT40-ER11-6"	19	19	6"	1-7
CAT40-ER16-6"	28	28	6"	1-10
CAT40-ER20-6"	34	34	6"	1-13
CAT40-ER16-8"	28	28	8"	1-10
CAT40-ER20-8"	34	34	8"	1-13
CAT50-ER16-2"	28	28	2"	1-10
CAT50-ER20-2"	34	34	2"	1-13
CAT50-ER16-4"	28	28	4"	1-10
CAT50-ER20-4"	34	34	4"	1-13
CAT50-ER16-6"	28	28	6"	1-10
CAT50-ER20-6"	34	34	6"	1-13
CAT50-ER16-8"	28	28	8"	1-10
CAT50-ER20-8"	34	34	8"	1-13

ER Collet Chuck, Short

ER 弹簧夹头刀柄, 超短型

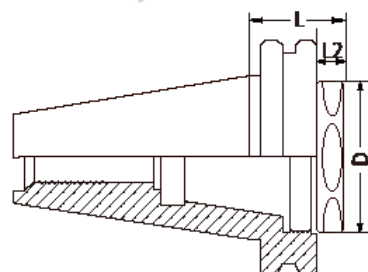

Size	D	L	L1
CAT40-ER25-1.1"	29.5	1.1"	0.35"
CAT40-ER32-1.1"	37.5	1.1"	0.35"

Power Milling Chuck
强力铣刀柄

A ↗
≤0.008

AD

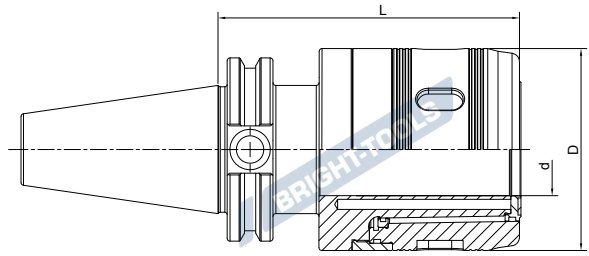

Size	d	D	L	Collet
CAT40-HC3/4"-4"	3/4"	50	4"	C3/4"
CAT40-HC1"-4"	1"	59	4"	C1"
CAT40-HC1-1/4"-5"	1.25"	70	5"	C1-1/4"
CAT50-HC3/4"-4'	3/4"	50	4"	C3/4"
CAT50-HC1"-4"	1"	59	4"	C1"
CAT50-HC1-1/4"-4"	1.25"	70	4"	C1-1/4"

CAT



Power Milling Chuck
强力铣刀柄
NEW

 ≤ 0.005

AD

Type 1

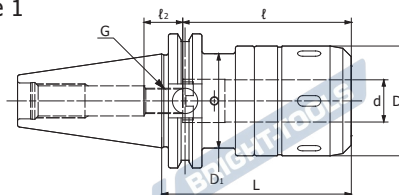

Type 2

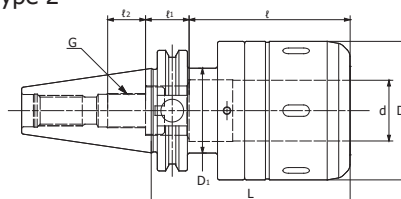

Size	Type	d	D	D1	L	ℓ	ℓ1	ℓ2	G
CAT40-CT16SA-90	1	0.630	1.772	1.750	3.543	2.559	-	0.787	BL16
CAT40-CT20SA-90	1	0.787	2.047	1.750	3.543	3.150	-	0.591	BL20
CAT40-CT20SA-105	1	0.787	2.047	1.750	4.134	3.150	-	0.591	BL20
CAT40-CT20SA-120	1	0.787	2.047	1.750	4.724	3.150	-	0.591	BL20
CAT40-CT25SA-105	1	0.984	2.402	1.750	4.134	3.150	-	0.591	BL20
CAT40-CT25SA-120	1	0.984	2.402	1.750	4.724	3.150	-	0.591	BL20
CAT40-CT25SA-135	1	0.984	2.402	1.750	5.315	3.150	-	0.591	BL20
CAT40-CT32SA-105	2	1.260	2.874	1.750	4.134	3.346	0.906	0.787	BL32
CAT40-CT32SA-120	2	1.260	2.874	1.750	4.724	3.346	0.906	0.787	BL32
CAT40-CT32SA-135	2	1.260	2.874	1.750	5.315	4.724	-	0.787	BL32
CAT50-CT16SA-90	1	0.630	1.772	2.750	3.543	2.559	-	0.787	BL16
CAT50-CT16SA-105	1	0.630	1.772	2.750	4.134	2.559	-	0.787	BL16
CAT50-CT20SA-90	1	0.787	2.047	2.750	3.543	3.150	-	0.591	BL20
CAT50-CT20SA-105	1	0.787	2.047	2.750	4.134	3.150	-	0.591	BL20
CAT50-CT20SA-135	1	0.787	2.047	2.750	5.315	3.150	-	0.591	BL20
CAT50-CT25SA-105	1	0.984	2.402	2.750	4.134	3.150	-	0.591	BL20
CAT50-CT25SA-135	1	0.984	2.402	2.750	5.315	3.150	-	0.591	BL20
CAT50-CT25SA-165	1	0.984	2.402	2.750	6.496	3.150	-	0.591	BL20
CAT50-CT32SA-95	1	1.260	2.874	2.750	3.740	4.724	-	0.787	BL32
CAT50-CT32SA-105	1	1.260	2.874	2.750	4.134	4.724	-	0.787	BL32
CAT50-CT32SA-120	1	1.260	2.874	2.750	4.724	4.724	-	0.787	BL32
CAT50-CT32SA-135	1	1.260	2.874	2.750	5.315	4.724	-	0.787	BL32
CAT50-CT32SA-150	1	1.260	2.874	2.750	5.906	4.724	-	0.787	BL32
CAT50-CT32SA-165	1	1.260	2.874	2.750	6.496	4.724	-	0.787	BL32
CAT50-CT42SA-105	1	1.654	3.465	2.750	4.134	4.724	-	0.787	BL32
CAT50-CT42SA-120	1	1.654	3.465	2.750	4.724	4.724	-	0.787	BL32
CAT50-CT42SA-135	1	1.654	3.465	2.750	5.315	4.724	-	0.787	BL32
CAT50-CT42SA-150	1	1.654	3.465	2.750	5.906	4.724	-	0.787	BL32
CAT50-CT42SA-165	1	1.654	3.465	2.750	6.496	4.724	-	0.787	BL32

CAT

TG Collet Chuck
TG 超强力刀柄

A ↗ ≤0.005	RPM G2.5/20000	AD
---------------	-------------------	----

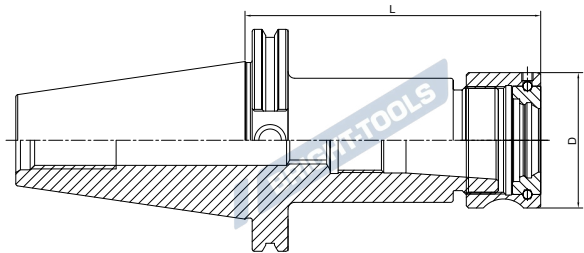

Size	D	L	Collet	Capacity
CAT40-TG75-2.54"	1.968"	2.54"	TG 75	0.094 - 0.75"
CAT40-TG100-2.76"	2.362"	2.76"	TG 100	0.094 - 1.0"

RPM G6.3/15000

Size	D	L	Collet	Capacity
CAT50-TG75-2.54"	1.968"	2.54"	TG 75	0.094 - 0.75"
CAT50-TG100-3.26"	2.362"	3.26"	TG 100	0.094 - 1.0"

CAT



Face Mill Holder Inch 英制面铣刀柄

A ↗	RPM
≤0.005	G2.5/25000

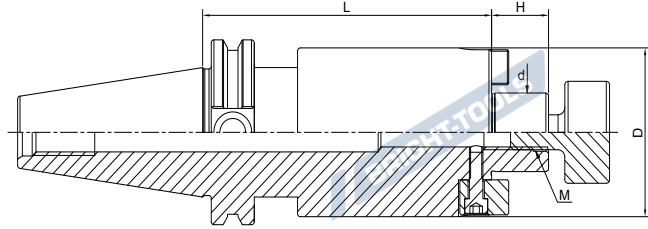

CAT

Size	d	D	L	H	M
CAT40-FMA1/2"-1.75"	1/2"	36.576	1.75"	13.97	1/4-28
CAT40-FMA3/4"-1.75"	3/4"	42.926	1.75"	17.45	3/8-24
CAT40-FMA1"-2"	1"	55.626	2"	17.45	1/2-20
CAT40-FMA1-1/4"-2"	1-1/4"	69.85	2"	17.45	5/8-18
CAT40-FMA1-1/2"-2"	1-1/2"	78	2"	23.83	3/4-16
CAT40-FMA1/2"-4"	1/2"	36.576	4"	13.97	1/4-28
CAT40-FMA3/4"-4"	3/4"	42.926	4"	17.45	3/8-24
CAT40-FMA1"-4"	1"	55.626	4"	17.45	1/2-20
CAT40-FMA1-1/4"-4"	1-1/4"	69.85	4"	17.45	5/8-18
CAT40-FMA1-1/2"-4"	1-1/2"	78	4"	23.83	3/4-16
CAT40-FMA3/4"-6"	3/4"	42.926	6"	17.45	3/8-24
CAT40-FMA1"-6"	1"	55.626	6"	17.45	1/2-20
CAT40-FMA3/4"-8"	3/4"	42.926	8"	17.45	3/8-24
CAT40-FMA1"-8"	1"	55.626	8"	17.45	1/2-20
CAT50-FMA1/2"-1.38"	1/2"	36.576	1.38"	13.97	1/4-28
CAT50-FMA3/4"-2"	3/4"	42.926	2"	17.45	3/8-24
CAT50-FMA1"-2"	1"	55.626	2"	17.45	1/2-20
CAT50-FMA1-1/4"-2"	1-1/4"	69.85	2"	17.45	5/8-18
CAT50-FMA1-1/2"-2"	1-1/2"	78	2"	23.83	3/4-16
CAT50-FMA2"-2"	2"	98	2"	23.83	1-14
CAT50-FMA3/4"-4"	3/4"	42.926	4"	17.45	3/8-24
CAT50-FMA1"-4"	1"	55.626	4"	17.45	1/2-20
CAT50-FMA1-1/4"-4"	1-1/4"	69.85	4"	17.45	5/8-18
CAT50-FMA1-1/2"-4"	1-1/2"	78	4"	23.83	3/4-16
CAT50-FMA2"-4"	2"	98	4"	23.83	1-14
CAT50-FMA3/4"-6"	3/4"	42.926	6"	17.45	3/8-24
CAT50-FMA1"-6"	1"	55.626	6"	17.45	1/2-20
CAT50-FMA1-1/4"-6"	1-1/4"	69.85	6"	17.45	5/8-18
CAT50-FMA1-1/2"-6"	1-1/2"	78	6"	23.83	3/4-16
CAT50-FMA3/4"-8"	3/4"	42.926	8"	17.45	3/8-24
CAT50-FMA1"-8"	1"	55.626	8"	17.45	1/2-20
CAT50-FMA1-1/4"-8"	1-1/4"	69.85	8"	17.45	5/8-18
CAT50-FMA1-1/2"-8"	1-1/2"	78	8"	23.83	3/4-16

End Mill Holder Weldon
侧固刀柄

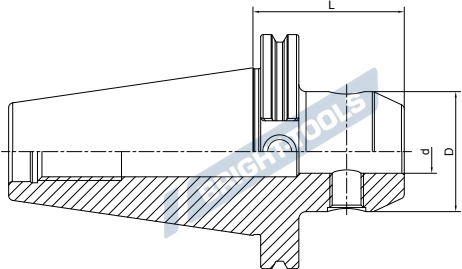

 DIN6359/1835B	 A ≤0.005	 RPM G2.5/20000	 AD
--	---	--	---





Size	d	D	L
CAT40-SLA1/8"-1.38"	1/8"	17.526	1.38"
CAT40-SLA3/16"-1.38"	3/16"	17.526	1.38"
CAT40-SLA1/4"-1.38"	1/4"	19.81	1.38"
CAT40-SLA5/16"-1.38"	5/16"	22.225	1.38"
CAT40-SLA3/8"-1.38"	3/8"	25.4	1.38"
CAT40-SLA1/2"-1.75"	1/2"	31.75	1.75"
CAT40-SLA5/8"-1.75"	5/8"	38.1	1.75"
CAT40-SLA3/4"-1.75"	3/4"	44.45	1.75"
CAT40-SLA7/8"-1.75"	7/8"	47.625	1.75"
CAT40-SLA1"-1.75"	1"	50.8	1.75"
CAT40-SLA1-1/4"-2"	1-1/4"	63.5	2"
CAT40-SLA1/8"-2.5"	1/8"	17.526	2.5"
CAT40-SLA3/16"-2.5"	3/16"	17.526	2.5"
CAT40-SLA1/4"-2.5"	1/4"	19.81	2.5"
CAT40-SLA5/16"-2.5"	5/16"	22.225	2.5"
CAT40-SLA3/8"-2.5"	3/8"	25.4	2.5"
CAT40-SLA7/16"-2.5"	7/16"	28.575	2.5"
CAT40-SLA1/2"-2.5"	1/2"	31.75	2.5"
CAT40-SLA5/8"-3"	5/8"	38.1	3"
CAT40-SLA3/4"-3"	3/4"	44.45	3"
CAT40-SLA7/8"-3.5"	7/8"	47.625	3.5"
CAT40-SLA1"-3"	1"	50.8	2"

CAT



End Mill Holder Weldon 侧固刀柄



 DIN6359/1835B	 A ↗ ≤0.005	 RPM G2.5/20000	 AD
--	--	--	---

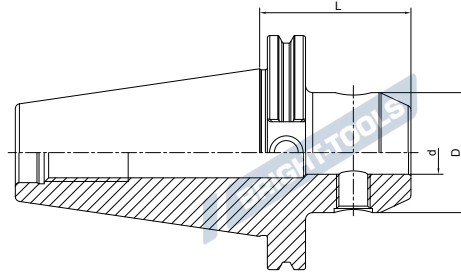

CAT

Size	d	D	L
CAT40-SLA1/8"-4"	1/8"	17.526	4"
CAT40-SLA3/16"-4"	3/16"	17.526	4"
CAT40-SLA1/4"-4"	1/4"	19.81	4"
CAT40-SLA5/16"-4"	5/16"	22.225	4"
CAT40-SLA3/8"-4"	3/8"	25.4	4"
CAT40-SLA1/2"-4"	1/2"	31.75	4"
CAT40-SLA5/8"-4"	5/8"	38.1	4"
CAT40-SLA3/4"-4"	3/4"	44.45	4"
CAT40-SLA1"-4"	1"	50.8	4"
CAT40-SLA1-1/4"-4"	1-1/4"	63.5	4"
CAT40-SLA1-1/2"-4"	1-1/2"	63.5	4"
CAT40-SLA1/4"-6"	1/4"	19.81	6"
CAT40-SLA5/16"-6"	5/16"	22.225	6"
CAT40-SLA3/8"-6"	3/8"	25.4	6"
CAT40-SLA1/2"-6"	1/2"	31.75	6"
CAT40-SLA5/8"-6"	5/8"	38.1	6"
CAT40-SLA3/4"-6"	3/4"	44.45	5.5"
CAT40-SLA7/8"-6"	7/8"	47.625	6"
CAT40-SLA1"-6"	1"	50.8	6"
CAT40-SLA1-1/4"-6"	1-1/4"	63.5	6"
CAT40-SLA1-1/2"-6"	1-1/2"	63.5	6"

End Mill Holder Weldon
侧固刀柄

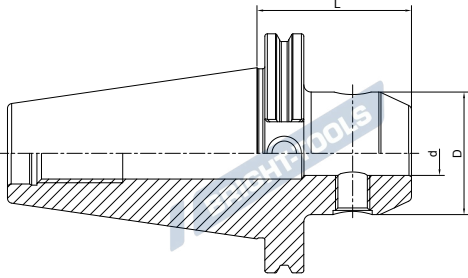

DIN6359/1835B	A \nearrow ≤ 0.005	RPM G2.5/15000	AD
---------------	---------------------------	-------------------	----



Size	d	D	L
CAT50-SLA3/16"-2.5"	3/16"	17.526	2.5"
CAT50-SLA1/4"-2.5"	1/4"	19.81	2.5"
CAT50-SLA5/16"-2.5"	5/16"	22.225	2.5"
CAT40-SLA3/8"-2.5"	3/8"	25.4	2.5"
CAT50-SLA7/16"-2.5"	7/16"	28.575	2.5"
CAT50-SLA1/2"-2.62"	1/2"	31.75	2.62"
CAT50-SLA5/8"-3"	5/8"	38.1	3"
CAT50-SLA3/4"-3"	3/4"	44.45	3"
CAT50-SLA1"-2"	1"	50.8	2"
CAT50-SLA1-1/4"-2"	1-1/4"	63.5	2"
CAT50-SLA1-1/2"-2.25"	1-1/2"	63.5	2.25"
CAT50-SLA2"-5.62"	2"	95.25	5.62"
CAT50-SLA1/4"-4"	1/4"	19.81	4"
CAT50-SLA5/16"-4"	5/16"	22.225	4"
CAT50-SLA3/8"-4"	3/8"	25.4	4"
CAT50-SLA7/16"-4"	7/16"	28.575	4"
CAT50-SLA1/2"-4"	1/2"	31.75	4"
CAT50-SLA5/8"-4"	5/8"	38.1	4"
CAT50-SLA3/4"-4"	3/4"	44.45	4"
CAT50-SLA7/8"-4"	7/8"	47.625	4"
CAT50-SLA1"-4"	1"	50.8	4"
CAT50-SLA1-1/4"-4"	1-1/4"	63.5	4"
CAT50-SLA1-1/2"- 4"	1-1/2"	63.5	4"
CAT50-SLA1/4"-6"	1/4"	19.81	6"
CAT50-SLA5/16"-6"	5/16"	22.225	6"
CAT50-SLA3/8"-6"	3/8"	25.4	6"
CAT50-SLA7/16"-6"	7/16"	28.575	6"
CAT50-SLA1/2"-6"	1/2"	31.75	6"
CAT50-SLA5/8"-6"	5/8"	38.1	6"
CAT50-SLA3/4"-6"	3/4"	44.45	6"
CAT50-SLA7/8"-6"	7/8"	47.625	6"
CAT50-SLA1"-6"	1"	50.8	6"
CAT50-SLA1-1/4"-6"	1-1/4"	63.5	6"
CAT50-SLA1-1/2"- 6"	1-1/2"	63.5	6"

CAT

End Mill Holder with Coolant Channels 侧固刀柄，端面出水型

 DIN6359/1835B	 A \nearrow ≤ 0.005	 RPM G2.5/20000	 AD
--	---	--	---

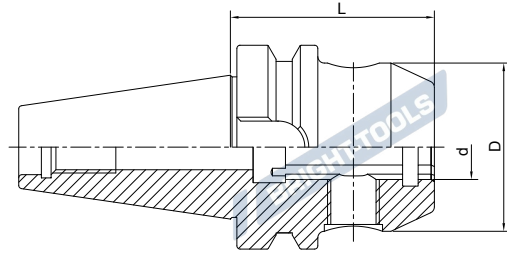
CAT

Size	d	D	L
CAT40-SLA1/8"-2.5"K	1/8"	17.526	2.5"
CAT40-SLA3/16"-2.5"K	3/16"	17.526	2.5"
CAT40-SLA1/4"-2.5"K	1/4"	19.81	2.5"
CAT40-SLA3/8"-2.5"K	3/8"	25.4	2.5"
CAT40-SLA7/16"-2.5"K	7/16"	28.575	2.5"
CAT40-SLA1/2"-2.5"K	1/2"	31.75	2.5"
CAT40-SLA5/8"-3"K	5/8"	38.1	3"
CAT40-SLA3/4"-3"K	3/4"	44.45	3"
CAT40-SLA7/8"-3.5"K	7/8"	47.625	3.5"
CAT40-SLA1"-3"K	1"	50.8	2"
CAT40-SLA1/8"-4"K	1/8"	17.526	4"
CAT40-SLA3/16"-4"K	3/16"	17.526	4"
CAT40-SLA1/4"-4"K	1/4"	19.81	4"
CAT40-SLA5/16"-4"K	5/16"	22.225	4"
CAT40-SLA3/8"-4"K	3/8"	25.4	4"
CAT40-SLA1/2"-4"K	1/2"	31.75	4"
CAT40-SLA1"-4"K	1"	50.8	4"
CAT40-SLA1-1/4"-4"K	1-1/4"	63.5	4"
CAT40-SLA1-1/2"-4"K	1-1/2"	63.5	4"
CAT40-SLA5/16"-6"K	5/16"	22.225	6"
CAT40-SLA3/8"-6"K	3/8"	25.4	6"
CAT40-SLA1/2"-6"K	1/2"	31.75	6"
CAT40-SLA5/8"-6"K	5/8"	38.1	6"
CAT40-SLA3/4"-6"K	3/4"	44.45	6"
CAT40-SLA1"-6"K	1"	50.8	6"
CAT40-SLA1-1/4"-6"K	1-1/4"	63.5	6"
CAT40-SLA1-1/2"-6"K	1-1/2"	63.5	6"

End Mill Holder with Coolant Channels
侧固刀柄，端面出水型

DIN6359/1835B	A ≤0.005	RPM G2.5/15000	AD
----------------------	------------------------	--------------------------	-----------

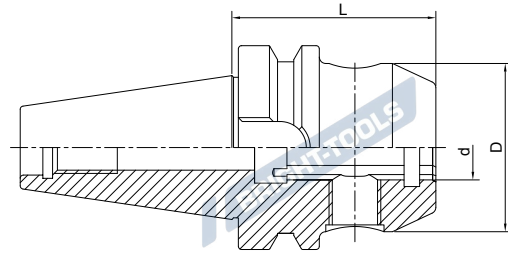

Size	d	D	L
CAT50-SLA1/4"-2.5"K	1/4"	19.81	2.5"
CAT50-SLA5/16"-2.5"K	5/16"	22.225	2.5"
CAT50-SLA3/8"-2.5"K	3/8"	25.4	2.5"
CAT50-SLA7/16"-2.5"K	7/16"	28.575	2.5"
CAT50-SLA1/2"-2.62"K	1/2"	31.75	2.62"
CAT50-SLA5/8"-3"K	5/8"	38.1	3"
CAT50-SLA3/4"-3"K	3/4"	44.45	3"
CAT50-SLA1"-2"K	1"	50.8	2"
CAT50-SLA1-1/2"- 2.25"K	1-1/2"	63.5	2.25"
CAT50-SLA2"-5.62"K	2"	95.25	5.62"
CAT50-SLA1/4"-4"K	1/4"	19.81	4"
CAT50-SLA5/16"-4"K	5/16"	22.225	4"
CAT50-SLA3/8"-4"K	3/8"	25.4	4"
CAT50-SLA7/16"-4"K	7/16"	28.575	4"
CAT50-SLA1/2"-4"K	1/2"	31.75	4"
CAT50-SLA5/8"-4"K	5/8"	38.1	4"
CAT50-SLA3/4"-4"K	3/4"	44.45	4"
CAT50-SLA7/8"-4"K	7/8"	47.625	4"
CAT50-SLA1"-4"K	1"	50.8	4"
CAT50-SLA1-1/4"-4"K	1-1/4"	63.5	4"
CAT50-SLA1-1/2"- 4"K	1-1/2"	63.5	4"
CAT50-SLA1/4"-6"K	1/4"	19.81	6"
CAT50-SLA5/16"-6"K	5/16"	22.225	6"
CAT50-SLA3/8"-6"K	3/8"	25.4	6"
CAT50-SLA7/16"-6"K	7/16"	28.575	6"
CAT50-SLA1/2"-6"K	1/2"	31.75	6"
CAT50-SLA5/8"-6"K	5/8"	38.1	6"
CAT50-SLA3/4"-6"K	3/4"	44.45	6"
CAT50-SLA7/8"-6"K	7/8"	47.625	6"
CAT50-SLA1"-6"K	1"	50.8	6"
CAT50-SLA1-1/4"-6"K	1-1/4"	63.5	6"
CAT50-SLA1-1/2"- 6"K	1-1/2"	63.5	6"

CAT

Morse Taper Adapter with Tang 带扁尾莫氏刀柄



DIN6383	A ≤ 0.005	RPM G2.5/25000
---------	----------------	-------------------

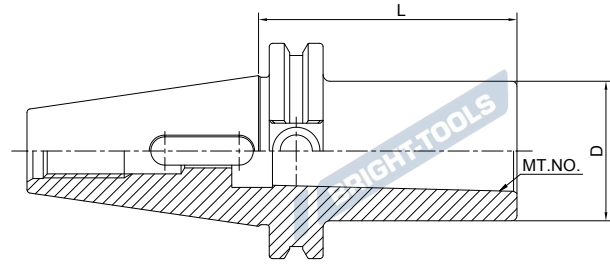

Size	MT. NO.	D	L
CAT40-MTA1-1.75"	1	25.40	1.75"
CAT40-MTA2-2"	2	31.75	2"
CAT40-MTA3-3"	3	41.45	3"
CAT40-MTA4-4"	4	50.80	4"
CAT50-MTA2-2"	2	31.75	2"
CAT50-MTA3-2"	3	41.45	2"
CAT50-MTA4-3"	4	50.80	3"
CAT50-MTA5-4"	5	69.85	4"

CAT

Tool Holder Adapter Sleeve 转换刀柄



A ≤ 0.005	AD
----------------	----

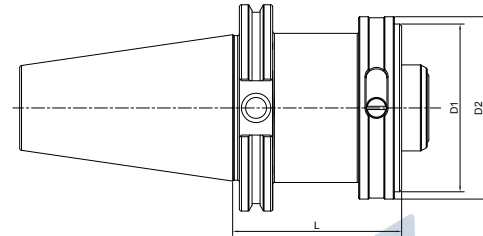

Size	D1	D2	L
CAT30-HSK32C-45	32	37	45
CAT30-HSK40C-60	40	45	60
CAT40-HSK32C-50	32	37	50
CAT40-HSK40C-50	40	45	50
CAT40-HSK50C-60	50	55	60
CAT40-HSK63C-75	63	70	75
CAT50-HSK32C-50	32	37	50
CAT50-HSK40C-50	40	45	50
CAT50-HSK50C-55	50	55	55
CAT50-HSK63C-55	63	70	55
CAT50-HSK80C-80	80	87	80
CAT50-HSK100C-95	100	110	95

Drill Chuck Adapter
钻接杆

DIN238	A \nearrow ≤ 0.005	RPM G2.5/25000
--------	------------------------------	-------------------

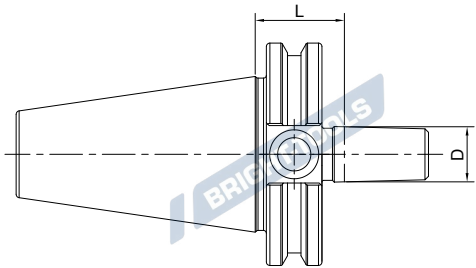

Size	D	L
CAT40-JT2-1.5"	14.199	1.5"
CAT40-JT3-1.5"	20.599	1.5"
CAT40-JT4-1.5"	28.55	1.5"
CAT40-JT6-1.5"	17.17	1.5"
CAT40-JT33-1.5"	15.85	1.5"
CAT50-JT2-1.5"	14.199	1.5"
CAT50-JT3-1.5"	20.599	1.5"
CAT50-JT4-1.5"	28.55	1.5"
CAT50-JT6-1.5"	17.17	1.5"
CAT50-JT33-1.5"	15.85	1.5"

CAT

APU Drill Chuck Holder
APU 钻夹头刀柄

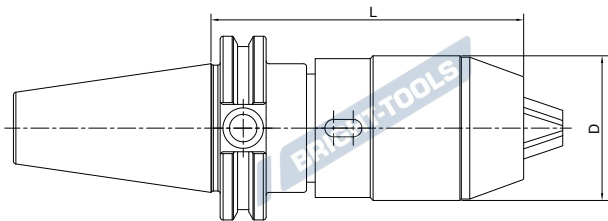

Size	D	L	Capacity
CAT40-APU08-85	36	85	1-8
CAT40-APU13-100	48	100	1-13
CAT40-APU16-110	53	110	3-16
CAT50-APU13-100	48	100	1-13
CAT50-APU16-105	53	105	3-16

Precision Drill Chuck Holder

精密钻夹头刀柄



A ↗	RPM
≤0.03	G2.5/25000

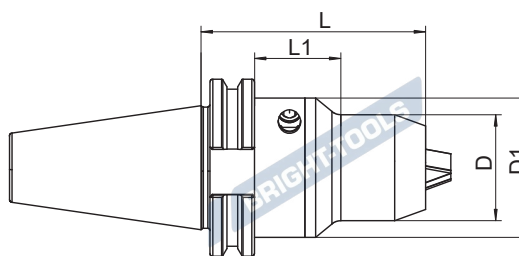

Size	D	D1	L	L1	Capacity
CAT40-CPU10-80	38	-	80	28.9	1-10
CAT40-CPU13-90	50	-	90	-	1-13
CAT40-CPU16-90	50	-	90	-	1-16
		-			
CAT50-CPU13-100	50	-	100	-	1-13
CAT50-CPU16-100	50	-	100	-	1-16

CAT

Quick Change Tapping Chuck with Length Compensation

弹性快换攻丝刀柄

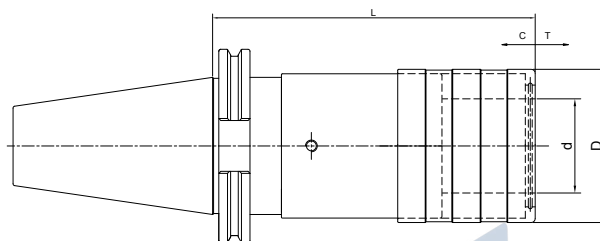

Size	D	d	L	T	C
CAT40-TC312-65	36	19	65	7.5	7.5
CAT40-TC820-93	54	31	93	12.5	12.5
CAT40-TC1433-156	78	48	156	22	22
CAT50-TC312-100	36	19	100	7.5	7.5
CAT50-TC820-100	54	31	100	12.5	12.5
CAT50-TC1433-142	78	48	142	22	22

Screw-in Milling Cutter Holder
锁牙刀柄，锥柄型



A ↗ ≤0.005	RPM G6.3/15000	AD
---------------	-------------------	--------

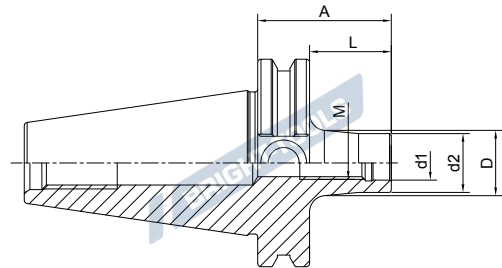

Size	M	d1	d2	A	L	D
CAT40-SOM08-44 L=25	8	8.5	14.5	44	25	15
CAT40-SOM08-69 L=50	8	8.5	14.5	69	50	23
CAT40-SOM08-94 L=75	8	8.5	14.5	94	75	23
CAT40-SOM08-119 L=100	8	8.5	14.5	119	100	25
CAT40-SOM10-24 L=5	10	10.5	18	24	5	18
CAT40-SOM10-44 L=25	10	10.5	18	44	25	20
CAT40-SOM10-69 L=50	10	10.5	18	69	50	23
CAT40-SOM10-94 L=75	10	10.5	18	94	75	28
CAT40-SOM10-119 L=100	10	10.5	18	119	100	32
CAT40-SOM10-169 L=150	10	10.5	18	169	150	36.5
CAT40-SOM12-24 L=5	12	12.5	21	24	5	21
CAT40-SOM12-44 L=25	12	12.5	21	44	25	24
CAT40-SOM12-69 L=50	12	12.5	21	69	50	24
CAT40-SOM12-94 L=75	12	12.5	21	94	75	31
CAT40-SOM12-119 L=100	12	12.5	21	119	100	33
CAT40-SOM12-144 L=125	12	12.5	21	144	125	36
CAT40-SOM12-169 L=150	12	12.5	21	169	150	40
CAT40-SOM16-24 L=5	16	17	29	24	5	29
CAT40-SOM16-44 L=25	16	17	29	44	25	29
CAT40-SOM16-69 L=50	16	17	29	69	50	34
CAT40-SOM16-94 L=75	16	17	29	94	75	34
CAT40-SOM16-119 L=100	16	17	29	119	100	36
CAT40-SOM16-144 L=125	16	17	29	144	125	40
CAT40-SOM16-169 L=150	16	17	29	169	150	42.5

CAT



Screw-in Milling Cutter Holder
锁牙刀柄，锥柄型

A ↗ ≤0.005	RPM G6.3/15000	AD 
---------------	-------------------	---

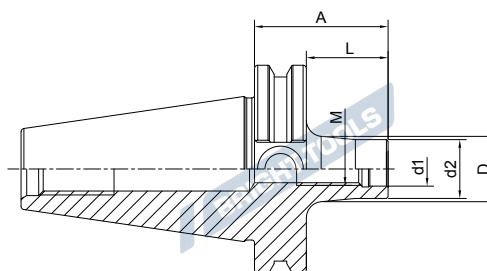

Size	M	d1	d2	A	L	D
CAT50-SOM08-69 L=50	8	8.5	14.5	69	50	23
CAT50-SOM08-119 L=100	8	8.5	14.5	119	100	25
CAT50-SOM08-169 L=150	8	8.5	14.5	169	150	30
CAT50-SOM10-69 L=50	10	10.5	18	69	50	23
CAT50-SOM10-119 L=100	10	10.5	18	119	100	32
CAT50-SOM10-169 L=150	10	10.5	18	169	150	36.5
CAT50-SOM12-69 L=50	12	12.5	21	69	50	24
CAT50-SOM12-119 L=100	12	12.5	21	119	100	33
CAT50-SOM12-169 L=150	12	12.5	21	169	150	40
CAT50-SOM16-69 L=50	16	17	29	69	50	34
CAT50-SOM16-119 L=100	16	17	29	119	100	36
CAT50-SOM16-169 L=150	16	17	29	169	150	42.5

CAT

Screw-in Milling Cutter Holder
锁牙刀柄，直柄型

A ↗ ≤0.005	RPM G6.3/15000	AD
---------------	-------------------	----

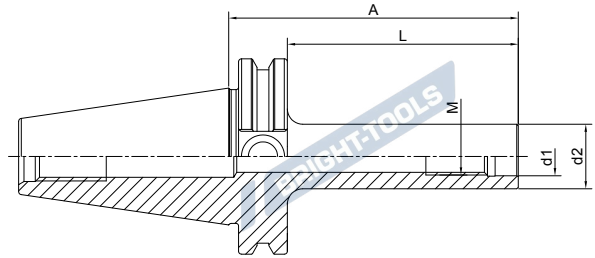

Size	M	d1	d2	A	L
CAT40-M10-119 L=100	10	10.5	18	119	100
CAT40-M10-169 L=150	10	10.5	18	169	150
CAT40-M12-119 L=100	12	12.5	21	119	100
CAT40-M12-144 L=125	12	12.5	21	144	125
CAT40-M12-169 L=150	12	12.5	21	169	150
CAT40-M16-119 L=100	16	17	29	119	100
CAT40-M16-144 L=125	16	17	29	144	125
CAT40-M16-169 L=150	16	17	29	169	150
CAT50-M10-119 L=100	10	10.5	18	119	100
CAT50-M10-169 L=150	10	10.5	18	169	150
CAT50-M12-119 L=100	12	12.5	21	119	100
CAT50-M12-169 L=150	12	12.5	21	169	150
CAT50-M16-119 L=100	16	17	29	119	100
CAT50-M16-169 L=150	16	17	29	169	150

CAT



Runout Adjustable Flange Adapter 可调节精度法兰刀柄

A ↗	RPM
≤0.002	G2.5/25000

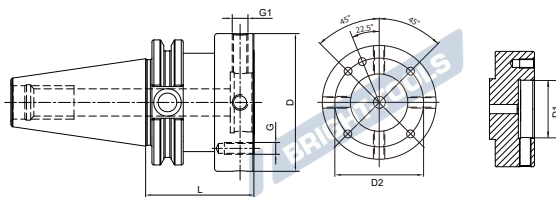

Size	D	D1	D2	L	G	G1
CAT40-MOD060-050	60	30	44	M5	M5	M8x1
CAT40-MOD070-050	70	35	53	M6	M6	M8x1
CAT40-MOD080-055	80	40	63	M6	M6	M8x1
CAT40-MOD100-060	100	50	79	M8	M8	M10x1
CAT50-MOD060-050	60	30	44	M5	M5	M8x1
CAT50-MOD070-050	70	35	53	M6	M6	M8x1
CAT50-MOD080-050	80	40	63	M6	M6	M8x1
CAT50-MOD100-060	100	50	79	M8	M8	M10x1
CAT50-MOD117-060	117	60	96	M8	M8	M10x1
CAT50-MOD140-060	140	80	119	M10	M10	M10x1

CAT

UM Adjustable Tool Holder UM 调零刀柄

A ↗	RPM
≤0.003	G2.5/25000

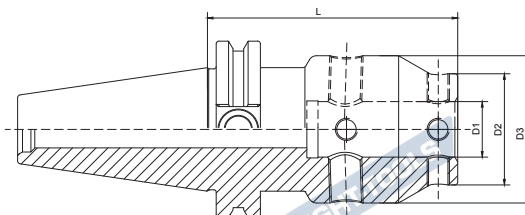

Size	D1	D2	D3	L
CAT40-UM12-65	12	28	44.5	65
CAT40-UM16-80	16	32	48	80
CAT40-UM20-90	20	40	53	90
CAT40-UM25-100	25	48	63	100
CAT40-UM32-105	32	52	63	105
CAT50-UM12-80	12	28	44.5	80
CAT50-UM16-80	16	32	48	80
CAT50-UM20-90	20	40	53	90
CAT50-UM25-100	25	48	63	100
CAT50-UM32-105	32	52	63	105

Boring Bar Blank
基础柄

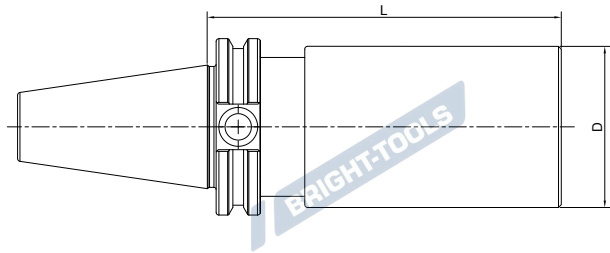

Size	D	L
CAT40-2.5"-6"	2.5"	6"
CAT40-2.5"-10"	2.5"	10"
CAT40-4"-6"	4"	6"
CAT40-4"-10"	4"	10"
CAT50-2.5"-6"	2.5"	6"
CAT50-2.5"-10"	2.5"	10"
CAT50-4"-6"	4"	6"
CAT50-4"-10"	4"	10"
CAT50-6"-10"	6"	10"

Other sizes can be made by request.

CAT

Test Arbor
主轴检测棒

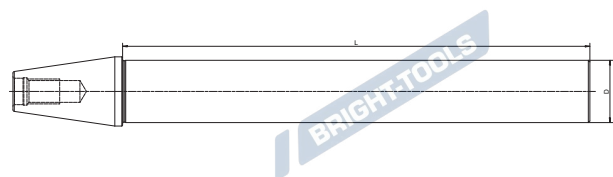
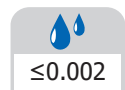

Size	D	L
CAT30-32-250	32	250
CAT40-40-300	40	300
CAT50-50-300	50	300

Other sizes can be made by request.

Alignment Tool for ATC Arm 调整机械手用组合模具

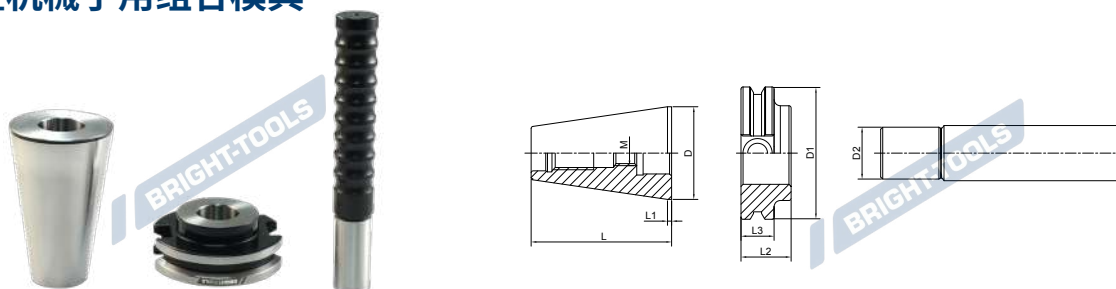

Size	D	D1	D2	L	L1	L2	L3	M
CAT30-ATC-18D	31.75	46	18	50.8	3.175	20	15.875	M12
CAT40-ATC-20D	44.45	63.5	20	71.43	3.175	25	15.875	M12
CAT50-ATC-28D	69.85	98.43	28	104.78	3.175	35	15.875	M16

Alignment Tool for ATC Arm 调整机械手用组合模具

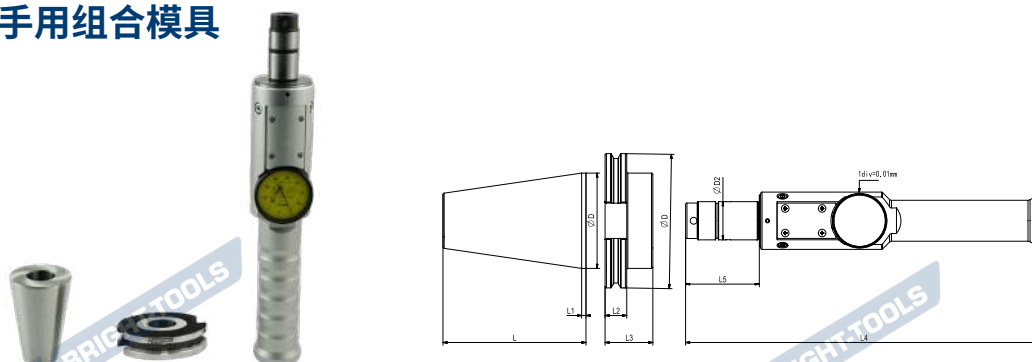

Size	D	D1	D2	L	L1	L2	L3	L4	L5
CAT40-ATC20	36.5	44.45	20	71.425	3.175	15.875	23	251	44
CAT50-ATC28	98.43	69.85	28	104.775	3.175	15.875	35	261	54

Usage:

1. Install the calibration taper to the machine spindle.
2. Install the calibration flange on the ATC machine.
3. Insert the calibration pin into the calibration flange.
4. Rotate the calibration pin to find the maximum and minimum positions of the pointer.
value position of the pointer. This direction is the direction of eccentricity, and the amount of eccentricity is half of the difference.
5. Adjust the ATC manipulator and ensure that the front of the calibration pin is fully inserted into the flange.

使用方法

1. 将校正锥柄安装到机床主轴。
2. 将校正法兰安装在 ATC 机械手上。
3. 将校正销棒插入校正法兰。
4. 旋转校正销棒，找到指针的最大值位置和最小值位置。
该方向即偏心方向，偏心量为差值的一半。
5. 调整 ATC 机械手并确保校正销棒前端完全插入法兰中。

BRIGHT-TOOLS

BRIGHT-TOOLS

TOOL HOLDERS

SCAT

BRIGHT-TOOLS

BRIGHT-TOOLS

BRIGHT-TOOLS

BRIGHT-TOOLS

BRIGHT-TOOLS

BRIGHT-TOOLS

SCAT DualDrive (Double Contact) Tool Holders

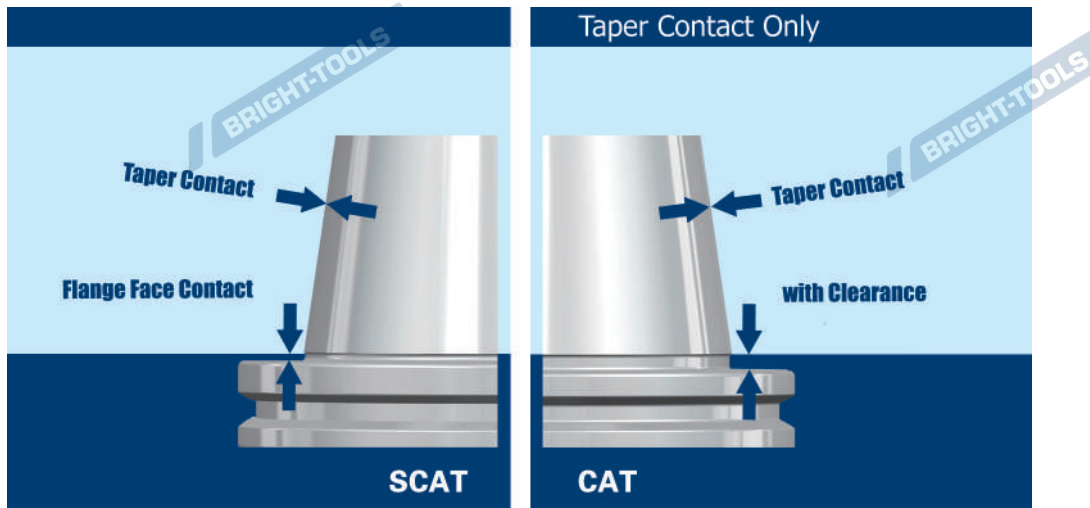
SCAT

Taper and Flange Face Dual Contact System Advantages:

- * Improve tool holder stability when high speed working.
- * Improve workpiece surface finish.
- * Improve working dimension accuracy.
- * Improve ATC repeatability.
- * Improve the roundness when boring operation.
- * Extend cutting tool life.

ORDER SPECIFICATION:

PLEASE ORDER SCAT SPINDLE MACHINING CENTERS FOR BETTER PERFORMANCE.

SCAT 双接触刀柄

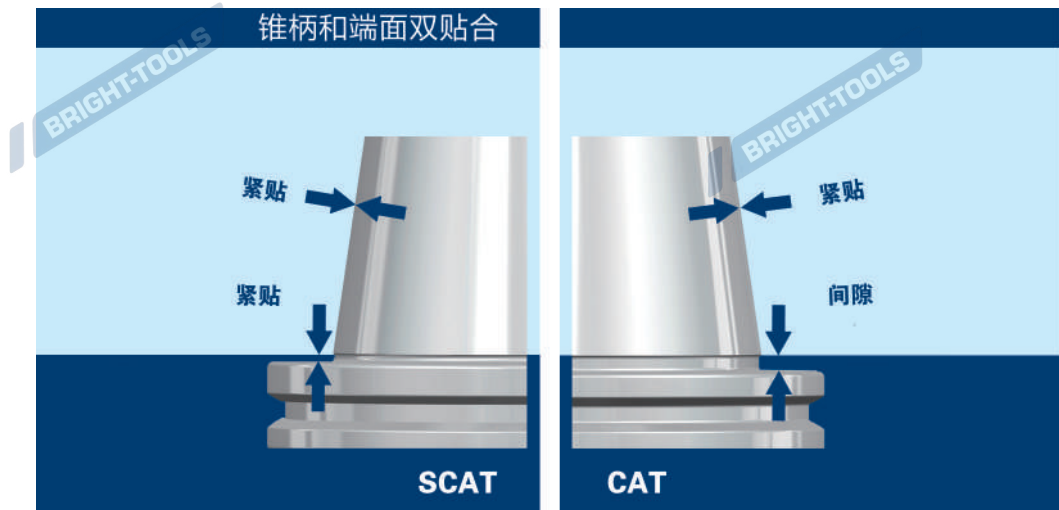

使用 SCAT 双接触刀柄优势：

- * 高速加工时提高刀柄稳定性；
- * 提高工件表面光洁度；
- * 提高加工精度；
- * 提高 ATC 的重复精度；
- * 提高镗孔加工圆度；
- * 增加刀具使用寿命。

订购说明：

为了更好的使用效果，请订购带 SCAT 主轴的加工中心。

ER Collet Chuck with UM Nut

ER 弹簧夹头刀柄

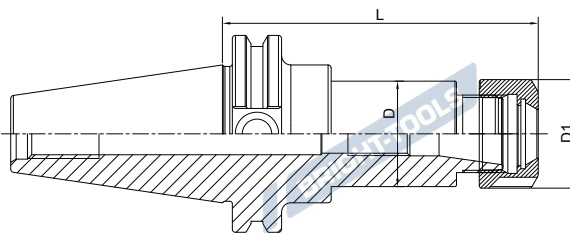
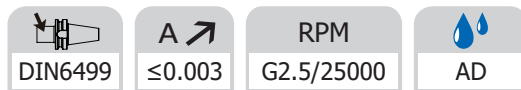

Size	D	D1	L	Capacity
SCAT40-ER16UM-2.5"	44.45	32	2.5"	1-10
SCAT40-ER20UM-2.5"	34	35	2.5"	1-13
SCAT40-ER25-2.5"	42	42	2.5"	2-16
SCAT40-ER32-2.5"	44.45	50	2.5"	2-20
SCAT40-ER40-3"	50	63	3"	3-26
SCAT40-ER16UM-4"	28	32	4"	1-10
SCAT40-ER20UM-4"	34	35	4"	1-13
SCAT40-ER25-4"	42	42	4"	2-16
SCAT40-ER32-4"	44.45	50	4"	2-20
SCAT40-ER40-4"	50	63	4"	3-26

SCAT

ER Collet Chuck with Hex Nut

ER 弹簧夹头刀柄

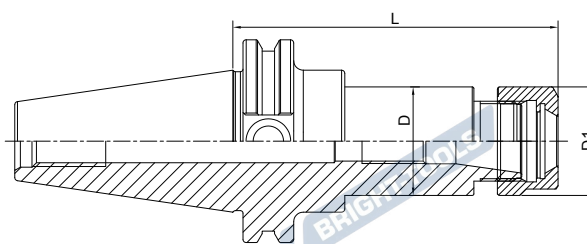
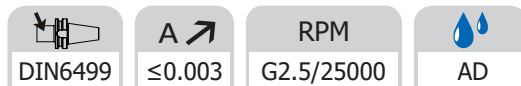

Size	D	D1	L	Capacity
SCAT40-ER11-2.5"	19	19	2.5"	1-7
SCAT40-ER16-2.5	44.45	28	2.5"	1-10
SCAT40-ER20-2.5	34	34	2.5"	1-13
SCAT40-ER11-4"	19	19	4"	1-7
SCAT40-ER16-4"	28	28	4"	1-10
SCAT40-ER20-4"	34	34	4"	1-13