

BRIGHT-TOOLS

BRIGHT-TOOLS

TOOL HOLDERS SK

BRIGHT-TOOLS

BRIGHT-TOOLS

BRIGHT-TOOLS

BRIGHT-TOOLS

BRIGHT-TOOLS

BRIGHT-TOOLS

SK Taper Standard

SK 锥柄标准

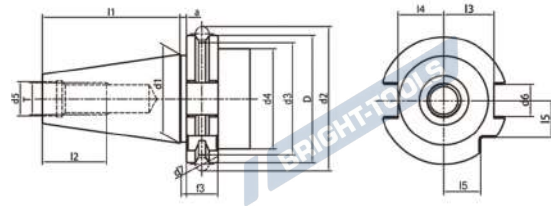
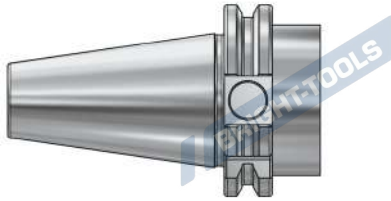

Size	D	d1	d2	d3	d4	d5	d6	d7	l1	l2	l3	l4	l5	e1	e2
SK30	50	31.75	59.3	44.3	45	13	16.1	7	47.8	24	18.8	16.3	15	21	5
SK40	63.55	44.45	72.3	56.25	50	17	16.1	7	58.4	32	25	22.7	18.5	27	5
SK50	97.5	69.85	107.36	91.25	80	25	25.7	7	101.8	47	37.7	35.5	30	42	7

Taper standard: DIN 69871

Material: Alloyed case hardened steel

Surface Treatment: Blackening and Bright

Taper tolerance: <AT3

Hardness: HRC 56-60

Carbon depth: 0.8±0.2mm

Surface Roughness: Ra<0.2µm

Balancing: G6.3/15000; G2.5/25000

Cooling: AD; AD/B can be made by request.

SK TOOLING SYSTEM

SK 工具系统目录

ER Collet Chuck.....	E.04
ER 弹簧夹头刀柄	
ER Collet Chuck, Shrot.....	E.08
ER 弹簧夹头刀柄,超短型	
Power Milling Chuck	E.08
强力铣刀柄	
OZ Collet C huck.....	E.11
OZ 夹头刀柄	
SKS Collet Chuck.....	E.11
SKS 高速筒夹刀柄	
Pull Back Collet Chuck	E.12
DC 后拉刀柄	
Precision Screw Collet Chuck.....	E.13
NDC后拉刀柄	
Face Mill Holder.....	E.14
面铣刀柄	
Combi Shell Mill Holder.....	E.17
混合插入式铣刀柄	
End Mill Holder.....	E.18
侧固刀柄	
Morse Taper Adapter.....	E.24
带扁尾莫氏刀柄	
Morse Taper Adapter.....	E.25
带螺纹孔莫氏刀柄	
Tool Holder Adapter Sleeve	E.26
转换刀柄	
Drill Chuck Adapter.....	E.27
钻接杆	
APU Drill Chuck Holder	E.27
APU 钻夹头刀柄	
Precision Drill Chuck Holder.....	E.28
精密钻夹头刀柄	
Quick Change Tapping Chuck.....	E.28
弹性快换攻丝刀柄	
Screw-in Milling Cutter Holder.....	E.29
SOM 锁牙刀柄	
Runout Adjustable Flange Adapter	E.32
可调节精度法兰刀柄	
UM Adjustable.....	E.32
UM调零刀柄	
Boring Bar Blank.....	E.33
基础柄	
Test Arbor.....	E.33
主轴检测棒	
Alignment Tool for ATC Arm	E.34
调整机械用手用组合模具	

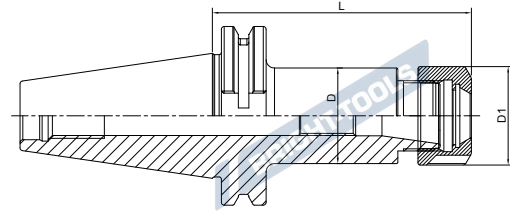
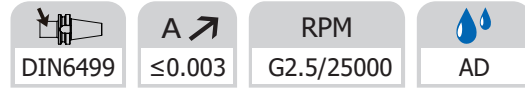

ER Collet Chuck with UM Nut ER 弹簧夹头刀柄

SK

Size	D	D1	L	Capacity
SK30-ER16UM-70	28	32	70	1-10
SK30-ER20UM-70	34	35	70	1-13
SK30-ER25-70	32	42	70	2-16
SK30-ER32-70	40	50	70	2-20
SK30-ER40-70	50	63	70	3-26
SK30-ER16UM-100	28	32	100	1-10
SK30-ER20UM-100	34	35	100	1-13
SK30-ER25-100	42	42	100	2-16
SK30-ER32-100	50	50	100	2-20
SK40-ER16UM-63	28	32	63	1-10
SK40-ER20UM-70	34	35	70	1-13
SK40-ER25-70	42	42	70	2-16
SK40-ER32-70	40	50	70	2-20
SK40-ER40-80	63	63	80	3-26
SK40-ER16UM-100	28	32	100	1-10
SK40-ER20UM-100	34	35	100	1-13
SK40-ER25-100	42	42	100	2-16
SK40-ER32-100	50	50	100	2-20
SK40-ER40-100	63	63	100	3-26
SK40-ER40-120	63	63	120	3-26
SK40-ER16UM-160	28	32	160	1-10
SK40-ER20UM-160	34	35	160	1-13
SK40-ER25-160	42	42	160	2-16
SK40-ER32-160	50	50	160	2-20
SK40-ER40-160	63	63	160	3-26
SK40-ER16UM-200	28	32	200	1-10
SK40-ER20UM-200	34	35	200	1-13
SK40-ER25-200	42	42	200	2-16
SK40-ER32-200	50	50	200	2-20
SK40-ER40-200	50	63	200	3-26

AD/B Customized

AD/B 可定制

ER Collet Chuck with UM Nut
ER 弹簧夹头刀柄

DIN6499	A \nearrow ≤ 0.003	RPM G2.5/25000	AD
---------	---------------------------	-------------------	----

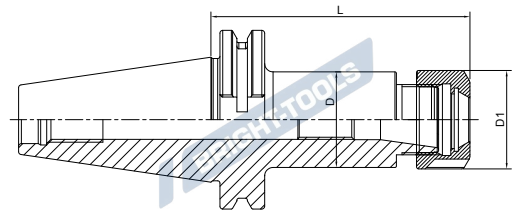

Size	D	D1	L	Capacity
SK50-ER16UM-70	28	32	70	1-10
SK50-ER20UM-70	34	35	70	1-13
SK50-ER25-60	42	42	60	2-16
SK50-ER32-70	50	50	70	2-20
SK50-ER40-80	63	63	80	3-26
SK50-ER50-100	100	78	100	6-34
SK50-ER16UM-100	28	32	100	1-10
SK50-ER20UM-100	34	35	100	1-13
SK50-ER25-100	42	42	100	2-16
SK50-ER32-100	50	50	100	2-20
SK50-ER40-100	63	63	100	3-26
SK50-ER16UM-160	28	32	160	1-10
SK50-ER20UM-160	34	35	160	1-13
SK50-ER25-160	42	42	160	2-16
SK50-ER32-160	50	50	160	2-20
SK50-ER40-160	63	63	160	3-26
SK50-ER16UM-200	28	32	200	1-10
SK50-ER20UM-200	34	35	200	1-13
SK50-ER25-200	42	42	200	2-16
SK50-ER32-200	50	50	200	2-20
SK50-ER40-200	63	63	200	3-26
SK60-ER32-100	50	50	100	2-20
SK60-ER40-100	63	63	100	3-26
SK60-ER50-100	64	78	100	6-34
SK60-ER32-160	50	50	160	2-20
SK60-ER40-160	63	63	160	3-26
SK60-ER50-160	64	78	160	6-34

AD/B Customized

AD/B 可定制

ER Collet Chuck with Hex Nut ER 弹簧夹头刀柄

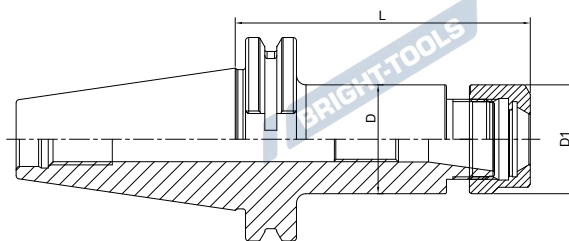
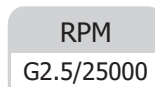
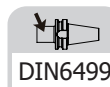
SK

Size	D	D1	L	Capacity
SK30-ER16-70	28	28	70	1-10
SK30-ER20-70	34	34	70	1-13
SK30-ER16-100	28	28	100	1-10
SK30-ER20-100	34	34	100	1-13
SK40-ER16-63	28	28	63	1-10
SK40-ER20-70	34	34	70	1-13
SK40-ER16-100	28	28	100	1-10
SK40-ER20-100	34	34	100	1-13
SK40-ER16-160T	28	28	160	1-10
SK40-ER20-160	34	34	160	1-13

RPM
G6.3/15000

Size	D	D1	L	Capacity
SK40-ER16-200T	28	28	200	1-10
SK40-ER20-200	34	34	200	1-13
SK50-ER16-70	28	28	70	1-10
SK50-ER20-70	34	34	70	1-13
SK50-ER16-100	28	28	100	1-10
SK50-ER20-100	34	34	100	1-13
SK50-ER16-160T	28	28	160	1-10
SK50-ER20-160	34	34	160	1-13
SK50-ER16-200T	28	28	200	1-10
SK50-ER20-200	34	34	200	1-13

AD/B Customized
T refers to cutter side with taper design

AD/B 可定制
T 代表刀具端锥柄设计

ER Collet Chuck with Mini Nut
ER 弹簧夹头刀柄

DIN6499	A ≤ 0.003	RPM G2.5/25000	AD
---------	----------------	----------------	----

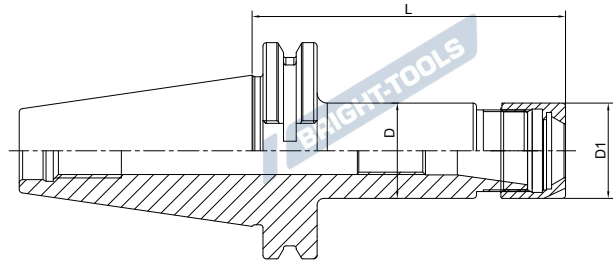

Size	D	D1	L	Capacity
SK40-ER11M-70	16	16	70	1-7
SK40-ER16M-70	22	22	70	1-10
SK40-ER20M-70	28	28	70	1-13
SK40-ER25M-70	35	35	70	2-16
SK40-ER11M-100	16	16	100	1-7
SK40-ER16M-100	22	22	100	1-10
SK40-ER20M-100	28	28	100	1-13
SK40-ER25M-100	35	35	100	2-16
SK40-ER11M-160T	16	16	160	1-7
SK40-ER16M-160T	22	22	160	1-10
SK40-ER20M-160	28	28	160	1-13
SK40-ER25M-160	35	35	160	2-16

RPM
G6.3/15000

Size	D	D1	L	Capacity
SK50-ER16M-70	22	22	70	1-10
SK50-ER20M-70	28	28	70	1-13
SK50-ER25M-70	35	35	70	2-16
SK50-ER16M-100	22	22	100	1-10
SK50-ER20M-100	28	28	100	1-13
SK50-ER25M-100	35	35	100	2-16
SK50-ER16M-160T	22	22	160	1-10
SK50-ER20M-160	28	28	160	1-13
SK50-ER25M-160	35	35	160	2-16

AD/B Customized
T refers to cutter side with taper design

AD/B 可定制
T 代表刀具端锥柄设计



ER Collet Chuck, Shrot
ER 弹簧夹头刀柄, 超短型

DIN6499	A ↗ ≤0.003	RPM G2.5/25000	AD
---------	------------	----------------	----

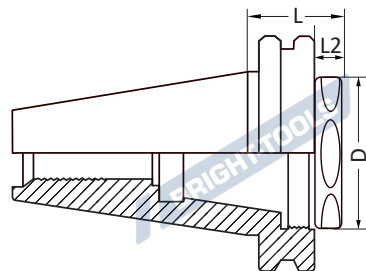

Size	D	L	L1
SK40-ER25-28	29.5	28	8.95
SK40-ER32-28	37.5	28	8.95

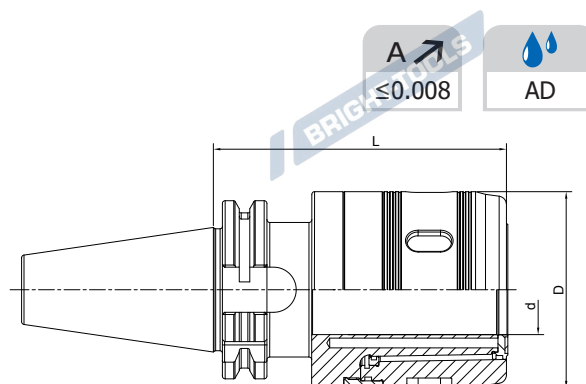
SK
Power Milling Chuck
强力铣刀柄

Size	d	D	L	Capacity
SK30-HC20-85	20	50	85	3-16; 20
SK30-HC20-100	20	50	100	3-16; 20
SK40-HC20-85	20	50	85	3-16; 20
SK40-HC25-100	25	59	100	3-20; 25
SK40-HC32-105	32	72	105	3-25; 32
SK50-HC20-105	20	50	105	3-16; 20
SK50-HC25-100	25	59	100	3-20; 25
SK50-HC32-110	32	72	110	3-25; 32
SK50-HC42-110	42	99	110	3-32; 42

Power Milling Chuck
强力铣刀柄

NEW

A ↗
 ≤0.005

AD

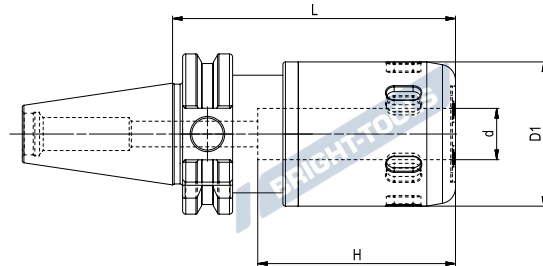

Size	d	D1	L	H
SK30-CT16SA-90	16	45	90	65
SK30-CT16SA-105	16	45	105	65
SK30-CT20SA-90	20	52	90	80
SK30-CT20SA-105	20	52	105	80
SK40-CT16SA-90	16	45	90	65
SK40-CT20SA-90	20	52	90	80
SK40-CT20SA-105	20	52	105	80
SK40-CT20SA-120	20	52	120	80
SK40-CT25SA-105	25	61	105	80
SK40-CT25SA-135	25	61	135	80
SK40-CT32SA-105	32	73	105	85
SK40-CT32SA-120	32	73	120	85
SK40-CT32SA-135	32	73	135	120

SK

BRIGHT-TOOLS

BRIGHT-TOOLS

BRIGHT-TOOLS

BRIGHT-TOOLS

Power Milling Chuck
强力铣刀柄
NEW

A ↗	AD
≤0.005	

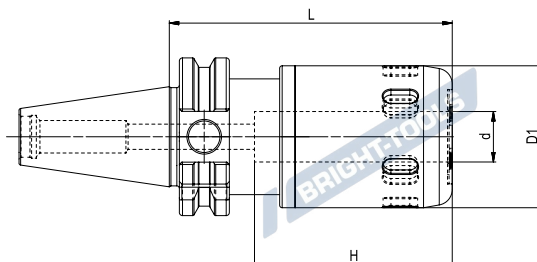
SK

Size	d	D1	L	H
SK50-CT16SA-90	16	45	90	65
SK50-CT16SA-105	16	45	105	65
SK50-CT16SA-135	16	45	135	65
SK50-CT20SA-90	20	52	90	80
SK50-CT20SA-105	20	52	105	80
SK50-CT20SA-120	20	52	120	80
SK50-CT20SA-135	20	52	135	80
SK50-CT20SA-165	20	52	165	80
SK50-CT20SA-200	20	52	200	80
SK50-CT20SA-250	20	52	250	80
SK50-CT20SA-300	20	52	300	80
SK50-CT25SA-105	25	61	105	80
SK50-CT25SA-135	25	61	135	80
SK50-CT25SA-165	25	61	165	80
SK50-CT25SA-200	25	61	200	80
SK50-CT25SA-250	25	61	250	80
SK50-CT25SA-300	25	61	300	80
SK50-CT32SA-95	32	73	95	120
SK50-CT32SA -105	32	73	105	120
SK50-CT32SA-120	32	73	120	120
SK50-CT32SA-135	32	73	135	120
SK50-CT32SA-150	32	73	150	120
SK50-CT32SA-165	32	73	165	120
SK50-CT32SA-200	32	73	200	120
SK50-CT32SA-250	32	73	250	120
SK50-CT32SA-300	32	73	300	120

OZ Collet Chuck
OZ 夹头刀柄

DIN6391	A ≤ 0.005	RPM G6.3/15000	AD
---------	----------------	----------------	----

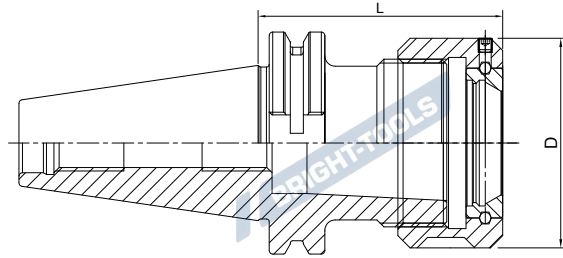

Size	D	L	Capacity
SK40-OZ16-70	43	70	2-16
SK40-OZ25-70	60	70	2-25
SK40-OZ32-90	72	90	4-32
SK40-OZ16-100	43	100	2-16
SK40-OZ25-100	60	100	2-25
SK50-OZ25-70	60	70	2-25
SK50-OZ32-80	72	80	4-32

SK

High Speed SKS Collet Chuck
SKS 高速筒夹刀柄

A ≤ 0.003	RPM G2.5/25000	AD
----------------	----------------	----

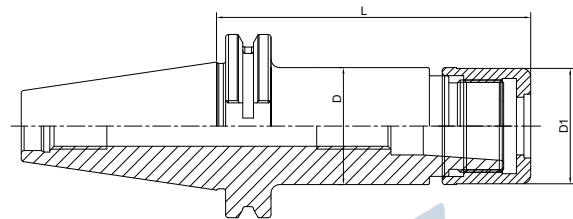

Size	D	D1	L	Capacity	M
SK40-SKS10-60	27.5	27	60	2-10	M21.5*1
SK40-SKS16-60	40.6	40	60	3-16	M32*1.5
SK40-SKS10-90	27.5	27	90	2-10	M21.5*1
SK40-SKS16-90	40.6	40	90	3-16	M32*1.5
SK40-SKS10-120	27.5	27	120	2-10	M21.5*1
SK40-SKS16-120	40.6	40	120	3-16	M32*1.5
SK50-SKS10-105	27.5	27	105	2-10	M21.5*1
SK50-SKS16-105	40.6	40	105	3-16	M32*1.5
SK50-SKS10-135	27.5	27	135	2-10	M21.5*1
SK50-SKS16-135	40.6	40	135	3-16	M32*1.5
SK50-SKS10-165	27.5	27	165	2-10	M21.5*1
SK50-SKS16-165	40.6	40	165	3-16	M32*1.5

Pull Back Collet Chuck DC 后拉刀柄

A ↗ ≤0.003	RPM G2.5/25000	AD
---------------	-------------------	----

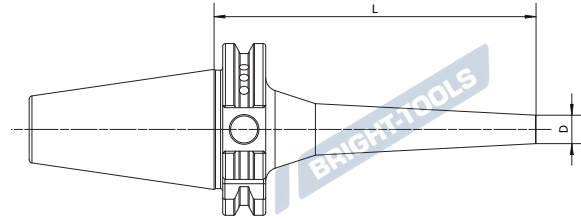
SK

Size	D	L	Capacity
SK30-DC06-60	14	60	1-6
SK30-DC06-90	14	90	1-6
SK30-DC06-120	14	120	1-6
SK30-DC08-60	22	60	1-10
SK30-DC08-90	22	90	1-10
SK30-DC08-120	22	120	1-10
SK30-DC12-80	34	80	1-12
SK40-DC06-60	14	60	1-6
SK40-DC06-90	14	90	1-6
SK40-DC06-120	14	120	1-6
SK40-DC06-150	14	150	1-6
SK40-DC08-60	22	60	1-10
SK40-DC08-90	22	90	1-10
SK40-DC08-120	22	120	1-10
SK40-DC08-150	22	150	1-10
SK40-DC08-200	22	200	1-10
SK40-DC12-90	34	90	1-12
SK40-DC12-120	34	120	1-12
SK40-DC12-150	34	150	1-12
SK40-DC12-200	34	200	1-12
SK50-DC06-110	14	110	1-6
SK50-DC06-150	14	150	1-6
SK50-DC08-110	22	110	1-10
SK50-DC08-150	22	150	1-10
SK50-DC08-200	22	200	1-10
SK50-DC12-120	34	120	1-12
SK50-DC12-150	34	150	1-12
SK50-DC12-200	34	200	1-12

Precision Screw Collet Chuck
NDC 后拉刀柄

A ↗ ≤0.003	RPM G2.5/25000	AD
---------------	-------------------	----

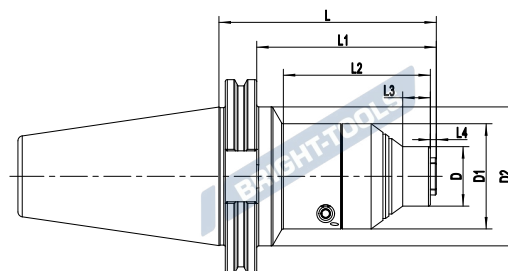

Size	D	D1	D2	L	L1	L2	L3	L4
SK40-NDC20-65	-	-	50	65	46	28	-	3
SK50-NDC14-110	30	53	70	110	91	75	14	3
SK50-NDC20-110	40	53	70	110	91	75	16	3

SK

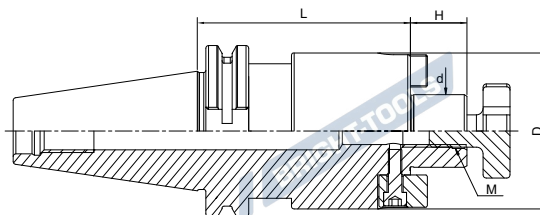
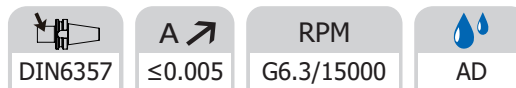

Face Mill Holder
面铣刀柄

SK

Size	d	D	L	H	M
SK30-FMB16-40	16	38	40	17	M8
SK30-FMB22-40	22	48	40	19	M10
SK30-FMB27-50	27	58	50	21	M12
SK30-FMB32-50	32	78	50	24	M16
SK40-FMB16-35	16	38	35	17	M8
SK40-FMB22-35	22	48	35	19	M10
SK40-FMB27-40	27	58	40	21	M12
SK40-FMB32-50	32	78	50	24	M16
SK40-FMB16-100	16	38	100	17	M8
SK40-FMB22-100	22	48	100	19	M10
SK40-FMB27-100	27	58	100	21	M12
SK40-FMB32-100	32	78	100	24	M16
SK40-FMB16-160	16	38	160	17	M8
SK40-FMB22-160	22	48	160	19	M10
SK40-FMB27-160	27	58	160	21	M12
SK40-FMB32-160	32	78	160	24	M16
SK40-FMB16-200	16	38	200	17	M8
SK40-FMB22-200	22	48	200	19	M10
SK40-FMB27-200	27	58	200	21	M12
SK40-FMB32-200	32	78	200	24	M16
SK40-FMB22-250	22	48	250	19	M10
SK40-FMB27-250	27	58	250	21	M12
SK40-FMB32-250	32	78	250	24	M16
SK40-FMB22-300	22	48	300	19	M10
SK40-FMB27-300	27	58	300	21	M12
SK40-FMB32-300	32	78	300	24	M16

AD/B Customized

AD/B 可定制

Face Mill Holder
面铣刀柄

DIN6357	A ≤ 0.005	RPM G6.3/15000	AD
---------	----------------	----------------	----

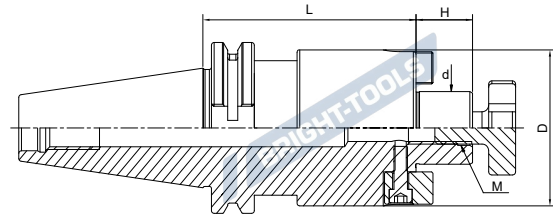

Size	d	D	L	H	M
SK50-FMB16-35	16	38	35	17	M8
SK50-FMB22-35	22	48	35	19	M10
SK50-FMB27-40	27	58	40	21	M12
SK50-FMB32-50	32	78	50	24	M16
SK50-FMB16-100	16	38	100	17	M8
SK50-FMB22-100	22	48	100	19	M10
SK50-FMB27-100	27	58	100	21	M12
SK50-FMB32-100	32	78	100	24	M16
SK50-FMB16-160	16	38	160	17	M8
SK50-FMB22-160	22	48	160	19	M10
SK50-FMB27-160	27	58	160	21	M12
SK50-FMB32-160	32	78	160	24	M16
SK50-FMB16-200	16	38	200	17	M8
SK50-FMB22-200	22	48	200	19	M10
SK50-FMB27-200	27	58	200	21	M12
SK50-FMB32-200	32	78	200	24	M16
SK50-FMB22-250	22	48	250	19	M10
SK50-FMB27-250	27	58	250	21	M12
SK50-FMB32-250	32	78	250	24	M16
SK50-FMB22-300	22	48	300	19	M10
SK50-FMB27-300	27	58	300	21	M12
SK50-FMB32-300	32	78	300	24	M16
SK60-FMB22-100	22	48	100	19	M10
SK60-FMB27-100	27	58	100	21	M12
SK60-FMB32-100	32	78	100	24	M16
SK60-FMB22-150	22	48	150	19	M10

AD/B Customized

AD/B 可定制

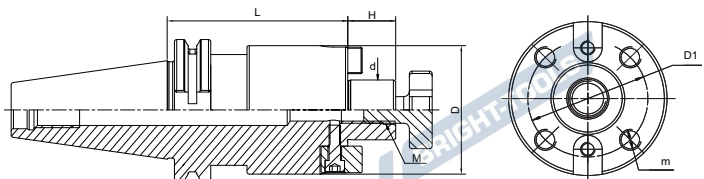
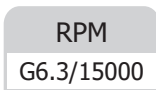
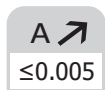
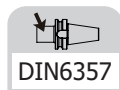
Face Mill Holder
面铣刀柄

SK

Size	d	D	D1	L	H	M	m
SK40-FMB40-50	40	88	66.7	50	27	M20	M12
SK40-FMB40-100	40	88	66.7	100	27	M20	M12
SK40-FMB40-160	40	88	66.7	160	27	M20	M12
SK40-FMB40-200	40	88	66.7	200	27	M20	M12
SK40-FMB40-250	40	88	66.7	250	27	M20	M12
SK40-FMB40-300	40	88	66.7	300	27	M20	M12
SK50-FMB40-50	40	88	66.7	50	27	M20	M12
SK50-FMB40-100	40	88	66.7	100	27	M20	M12
SK50-FMB40-160	40	88	66.7	160	27	M20	M12
SK50-FMB40-200	40	88	66.7	200	27	M20	M12
SK50-FMB40-250	40	88	66.7	250	27	M20	M12
SK50-FMB40-300	40	88	66.7	300	27	M20	M12
SK60-FMB40-100	40	88	66.7	100	27	M20	M12
SK60-FMB60-75	60	129	101.6	75	27	M30	M16

AD/B Customized

AD/B 可定制



Combi Shell Mill Holder
混合插入式铣刀柄



DIN6358	A \nearrow ≤ 0.005	RPM G6.3/15000
---------	---------------------------	-------------------

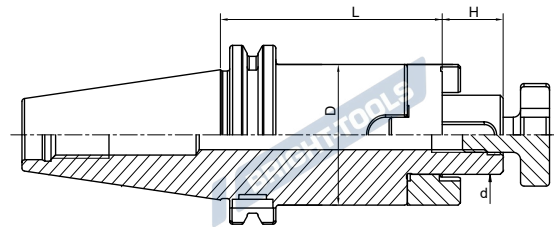

Size	d	D	l	L
SK30-SEMC16-50	16	32	17	50
SK30-SEMC22-50	22	40	19	50
SK30-SEMC27-55	27	48	21	55
SK30-SEMC32-60	32	58	24	60
SK40-SEMC16-55	16	32	17	55
SK40-SEMC22-55	22	40	19	55
SK40-SEMC27-55	27	48	21	55
SK40-SEMC32-55	32	58	24	55
SK40-SEMC40-60	40	70	27	60
SK40-SEMC16-100	16	32	17	100
SK40-SEMC22-100	22	40	19	100
SK40-SEMC27-100	27	48	21	100
SK40-SEMC32-100	32	58	24	100
SK40-SEMC40-100	40	70	27	100
SK40-SEMC16-160	16	32	17	160
SK40-SEMC22-160	22	40	19	160
SK40-SEMC27-160	27	48	21	160
SK40-SEMC32-160	32	58	24	160
SK40-SEMC40-160	40	70	27	160
SK50-SEMC16-55	16	32	17	55
SK50-SEMC22-55	22	40	19	55
SK50-SEMC27-55	27	48	21	55
SK50-SEMC32-60	32	58	24	60
SK50-SEMC40-55	40	70	27	60
SK50-SEMC16-100	16	32	17	100
SK50-SEMC22-100	22	40	19	100
SK50-SEMC27-100	27	48	21	100
SK50-SEMC32-100	32	58	24	100
SK50-SEMC40-100	40	70	27	100
SK50-SEMC16-160	16	32	17	160
SK50-SEMC22-160	22	40	19	160
SK50-SEMC27-160	27	48	21	160
SK50-SEMC32-160	32	58	24	160
SK50-SEMC40-160	40	70	27	160

SK

End Mill Holder Weldon 侧固刀柄

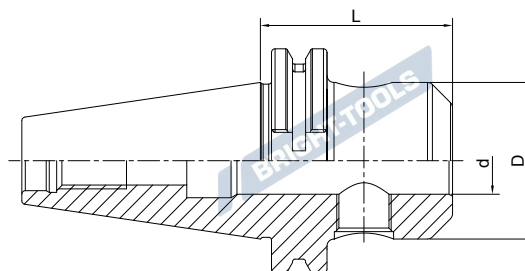
SK

Size	d	D	L	M	Screw Quantity
SK30-SLA06-50	6	25	50	M6	1
SK30-SLA08-50	8	28	50	M8	1
SK30-SLA10-50	10	35	50	M10	1
SK30-SLA12-50	12	42	50	M12	1
SK30-SLA14-63	14	44	63	M12	1
SK30-SLA16-63	16	48	63	M14	1
SK30-SLA18-63	18	50	63	M14	1
SK30-SLA20-70	20	52	70	M16	1
SK40-SLA06-50	6	25	50	M6	1
SK40-SLA08-50	8	28	50	M8	1
SK40-SLA10-50	10	35	50	M10	1
SK40-SLA12-50	12	42	50	M12	1
SK40-SLA14-50	14	44	50	M12	1
SK40-SLA16-63	16	48	63	M14	1
SK40-SLA18-63	18	50	63	M14	1
SK40-SLA20-63	20	52	63	M16	1
SK40-SLA25-100	25	65	100	M18*2	2
SK40-SLA32-100	32	72	100	M20*2	2
SK40-SLA40-120	40	80	120	M20*2	2
SK40-SLA06-100	6	25	100	M6	1
SK40-SLA08-100	8	28	100	M8	1
SK40-SLA10-100	10	35	100	M10	1
SK40-SLA12-100	12	42	100	M12	1
SK40-SLA14-100	14	44	100	M12	1
SK40-SLA16-100	16	48	100	M14	1
SK40-SLA18-100	18	50	100	M14	1
SK40-SLA20-100	20	52	100	M16	1

AD/B Customized

AD/B 可定制

End Mill Holder Weldon
侧固刀柄



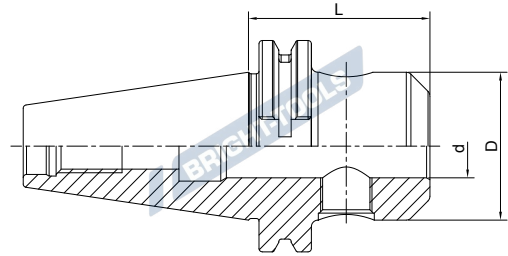

 DIN6359/1835B	 A ≤0.005	 RPM G6.3/15000	 AD
--	---	---	---



Size	d	D	L	M	Screw Quantity
SK40-SLA06-160	6	25	160	M6	1
SK40-SLA08-160	8	28	160	M8	1
SK40-SLA10-160	10	35	160	M10	1
SK40-SLA12-160	12	42	160	M12	1
SK40-SLA14-160	14	44	160	M12	1
SK40-SLA16-160	16	48	160	M14	1
SK40-SLA18-160	18	50	160	M14	1
SK40-SLA20-160	20	52	160	M16	1
SK40-SLA25-160	25	65	160	M18*2	2
SK40-SLA32-160	32	72	160	M20*2	2
SK40-SLA40-160	40	80	160	M20*2	2
SK50-SLA06-63	6	25	63	M6	1
SK50-SLA08-63	8	28	63	M8	1
SK50-SLA10-63	10	35	63	M10	1
SK50-SLA12-63	12	42	63	M12	1
SK50-SLA14-63	14	44	63	M12	1
SK50-SLA16-63	16	48	63	M14	1
SK50-SLA18-63	18	50	63	M14	1
SK50-SLA20-63	20	52	63	M16	1
SK50-SLA25-80	25	65	80	M18*2	2
SK50-SLA32-100	32	72	100	M20*2	2
SK50-SLA40-100	40	80	100	M20*2	2
SK50-SLA50-120	50	100	120	M24*2	2
SK50-SLA06-100	6	25	100	M6	1
SK50-SLA08-100	8	28	100	M8	1
SK50-SLA10-100	10	35	100	M10	1
SK50-SLA12-100	12	42	100	M12	1
SK50-SLA14-100	14	44	100	M12	1
SK50-SLA16-100	16	48	100	M14	1
SK50-SLA18-100	18	50	100	M14	1
SK50-SLA20-100	20	52	100	M16	1
SK50-SLA25-120	25	65	120	M18*2	2

SK

End Mill Holder Weldon 侧固刀柄

 DIN6359/1835B	 A ↗ ≤0.005	 RPM G6.3/15000	 AD
--	--	--	---

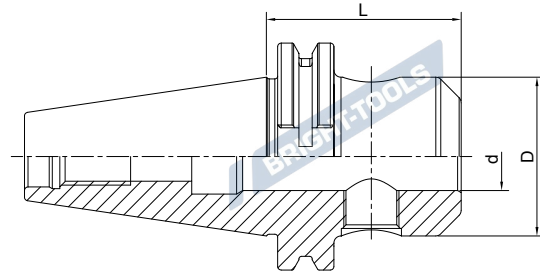
SK

Size	d	D	L	M	Screw Quantity
SK50-SLA06-160	6	25	160	M6	1
SK50-SLA08-160	8	28	160	M8	1
SK50-SLA10-160	10	35	160	M10	1
SK50-SLA12-160	12	42	160	M12	1
SK50-SLA14-160	14	44	160	M12	1
SK50-SLA16-160	16	48	160	M14	1
SK50-SLA18-160	18	50	160	M14	1
SK50-SLA20-160	20	52	160	M16	1
SK50-SLA25-160	25	65	160	M18*2	2
SK50-SLA32-160	32	72	160	M20*2	2
SK50-SLA40-160	40	80	160	M20*2	2
SK60-SLA20-100	20	52	100	M16	1
SK60-SLA25-100	25	65	100	M18*2	2
SK60-SLA32-100	32	72	100	M20*2	2
SK60-SLA40-100	40	80	100	M20*2	2
SK60-SLA50-120	50	90	120	M20*2	2

AD/B Customized

AD/B 可定制

End Mill Holder with Coolant Channels
侧固刀柄，端面出水型

DIN6359/1835B	A ↗ ≤0.005	RPM G6.3/15000	AD
---------------	------------	----------------	----

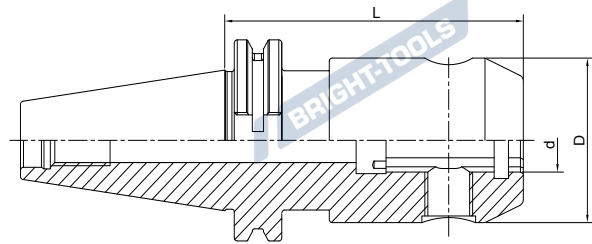

Size	d	D	L	M	Screw Quantity
SK40-SLA06-50K	6	25	50	M6	1
SK40-SLA08-50K	8	28	50	M8	1
SK40-SLA10-50K	10	35	50	M10	1
SK40-SLA12-50K	12	42	50	M12	1
SK40-SLA14-50K	14	44	50	M12	1
SK40-SLA16-63K	16	48	63	M14	1
SK40-SLA18-63K	18	50	63	M14	1
SK40-SLA20-63K	20	52	63	M16	1
SK40-SLA25-100K	25	65	100	M18*2	2
SK40-SLA32-100K	32	72	100	M20*2	2
SK40-SLA40-120K	40	80	120	M20*2	2
SK40-SLA06-100K	6	25	100	M6	1
SK40-SLA08-100K	8	28	100	M8	1
SK40-SLA10-100K	10	35	100	M10	1
SK40-SLA12-100K	12	42	100	M12	1
SK40-SLA14-100K	14	44	100	M12	1
SK40-SLA16-100K	16	48	100	M14	1
SK40-SLA18-100K	18	50	100	M14	1
SK40-SLA20-100K	20	52	100	M16	1

AD/B Customized

AD/B 可定制

SK



End Mill Holder with Coolant Channels 侧固刀柄，端面出水型

DIN6359/1835B	A ↗ ≤0.005	RPM G6.3/15000	AD
---------------	------------	----------------	----

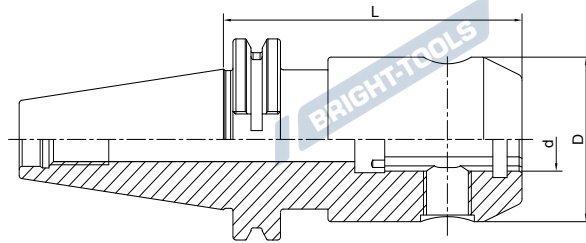
SK

Size	d	D	L	M	Screw Quantity
SK50-SLA06-63K	6	25	63	M6	1
SK50-SLA08-63K	8	28	63	M8	1
SK50-SLA10-63K	10	35	63	M10	1
SK50-SLA12-63K	12	42	63	M12	1
SK50-SLA16-63K	16	48	63	M14	1
SK50-SLA18-63K	18	50	63	M14	1
SK50-SLA20-63K	20	52	63	M16	1
SK50-SLA25-80K	25	65	80	M18*2	2
SK50-SLA32-100K	32	72	100	M20*2	2
SK50-SLA40-100K	40	80	100	M20*2	2
SK50-SLA06-100K	6	25	100	M6	1
SK50-SLA08-100K	8	28	100	M8	1
SK50-SLA10-100K	10	35	100	M10	1
SK50-SLA12-100K	12	42	100	M12	1
SK50-SLA14-100K	14	44	100	M12	1
SK50-SLA16-100K	16	48	100	M14	1
SK50-SLA18-100K	18	50	100	M14	1
SK50-SLA20-100K	20	52	100	M16	1
SK50-SLA25-120K	25	65	120	M18*2	2

AD/B Customized

AD/B 可定制

End Mill Holder Whistle Notch
侧固式铣刀柄，斜 2 度

DIN1835E	A \nearrow ≤ 0.005	RPM G6.3/15000	AD
----------	---------------------------	-------------------	----

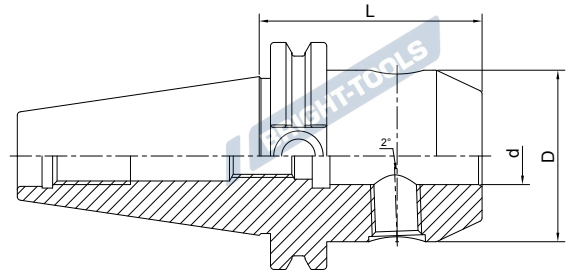

Size	d	D	L	M	Screw Quantity
SK40-SLB06-50	6	25	50	M6	1
SK40-SLB08-50	8	28	50	M8	1
SK40-SLB10-50	10	35	50	M10	1
SK40-SLB12-50	12	42	50	M12	1
SK40-SLB14-50	14	44	50	M12	1
SK40-SLB16-63	16	48	63	M14	1
SK40-SLB18-63	18	50	63	M14	1
SK40-SLB20-63	20	52	63	M16	1
SK40-SLB25-100	25	65	100	M18*2	2
SK40-SLB32-100	32	72	100	M20*2	2
SK40-SLB40-120	40	80	120	M20*2	2
SK50-SLB06-63	6	25	63	M6	1
SK50-SLB08-63	8	28	63	M8	1
SK50-SLB10-63	10	35	63	M10	1
SK50-SLB12-63	12	42	63	M12	1
SK50-SLB14-63	14	44	63	M12	1
SK50-SLB16-63	16	48	63	M14	1
SK50-SLB18-63	18	50	63	M14	1
SK50-SLB20-63	20	52	63	M16	1
SK50-SLB25-80	25	65	80	M18*2	2
SK50-SLB32-100	32	72	100	M20*2	2
SK50-SLB40-100	40	80	100	M20*2	2
SK50-SLB50-125	50	100	125	M24*2	2

AD/B Customized

AD/B 可定制



SK

Morse Taper Adapter with Tang 带扁尾莫氏刀柄



 DIN6383	 A ↗ ≤0.005	RPM G6.3/15000
--	--	-------------------

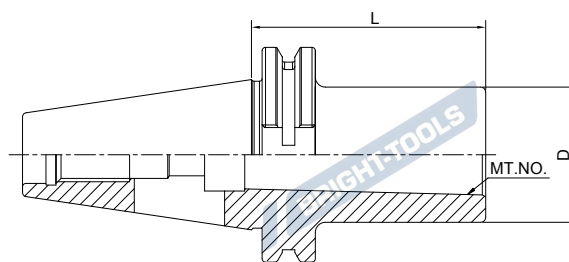

SK

Size	MT. NO.	D	L
SK30-MTA1-50	1	25	50
SK30-MTA2-65	2	32	65
SK30-MTA3-80	3	40	80
SK40-MTA1-50	1	25	50
SK40-MTA2-50	2	32	50
SK40-MTA3-70	3	40	70
SK40-MTA4-95	4	48	95
SK50-MTA1-45	1	25	45
SK50-MTA2-60	2	32	60
SK50-MTA3-65	3	40	65
SK50-MTA4-95	4	48	95
SK50-MTA5-105	5	63	105
SK60-MTA3-65	3	40	65
SK60-MTA4-95	4	48	95
SK60-MTA5-105	5	63	105
SK60-MTA6-170	6	85	170

Morse Taper Adapter with Drawbar
带螺纹孔莫氏刀柄

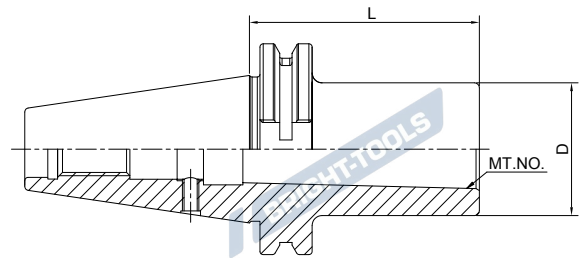

 DIN6364	 A ≤ 0.005	RPM G6.3/15000
---	--	-------------------



Size	MT. NO.	D	L
SK40-MTB1-50	1	25	50
SK40-MTB2-50	2	32	50
SK40-MTB3-70	3	40	70
SK40-MTB4-95	4	48	95
SK50-MTB1-45	1	25	45
SK50-MTB2-60	2	32	60
SK50-MTB3-65	3	40	65
SK50-MTB4-70	4	48	70
SK50-MTB5-100	5	63	100
SK60-MTB3-65	3	40	65
SK60-MTB4-70	4	48	70
SK60-MTB5-100	5	63	100
SK60-MTB6-150	6	85	150

SK



Tool Holder Adapter Sleeve 转换刀柄



A ↗	RPM
≤0.005	G6.3/15000

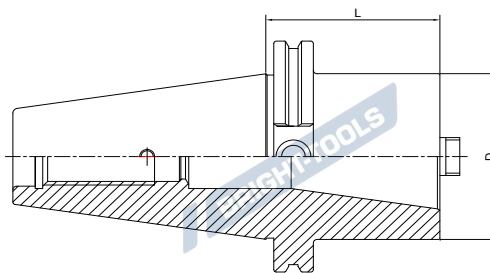

SK

Size	L	D
SK40-SK30-50	50	50
SK40-SK40-100	100	63
SK50-SK40-70	70	70
SK50-SK50-120	120	97
SK60-SK50-100	100	97

Tool Holder Adapter Sleeve 转换刀柄

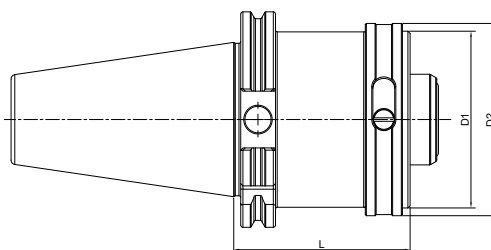

A ↗	AD
≤0.005	



Size	D1	D2	L
SK30-HSK32C-40	32	37	40
SK30-HSK40C-60	40	45	60
SK40-HSK32C-40	32	37	40
SK40-HSK40C-40	40	45	40
SK40-HSK50C-60	50	55	60
SK40-HSK63C-75	63	70	75
SK50-HSK32C-40	32	37	40
SK50-HSK40C-40	40	45	40
SK50-HSK50C-40	50	55	40
SK50-HSK63C-40	63	70	40
SK50-HSK80C-80	80	87	80
SK50-HSK100C-95	100	110	95

Drill Chuck Adapter
钻接杆



DIN238	A ≤ 0.005	RPM G6.3/15000
--------	----------------	-------------------

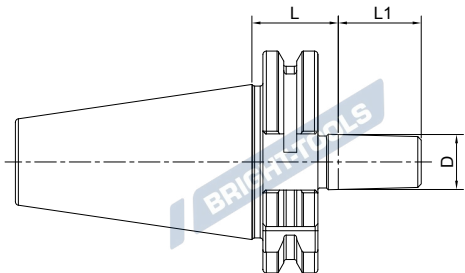

Size	D	L1	L
SK30-B12	B12	18.5	25
SK30-B16	B16	24	25
SK40-B12	B12	18.5	25
SK40-B16	B16	24	25
SK40-B18	B18	32	25
SK50-B12	B12	18.5	25
SK50-B16	B16	24	25
SK50-B18	B18	32	25

SK

APU Drill Chuck Holder
APU 钻夹头刀柄

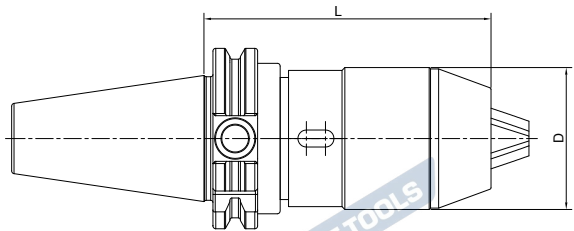

Size	D	L	Capacity
SK30-APU8-80	38	80	1-8
SK30-APU13-120	48	120	1-13
SK30-APU16-130	53	130	3-16
SK40-APU08-85	38	85	1-8
SK40-APU13-100	48	100	1-13
SK40-APU16-110	53	110	3-16
SK50-APU8-75	38	75	1-8
SK50-APU13-100	48	100	1-13
SK50-APU16-100	53	100	3-16

Precision Drill Chuck Holder 精密钻夹头刀柄

A ↗	RPM
≤0.03	G6.3/15000

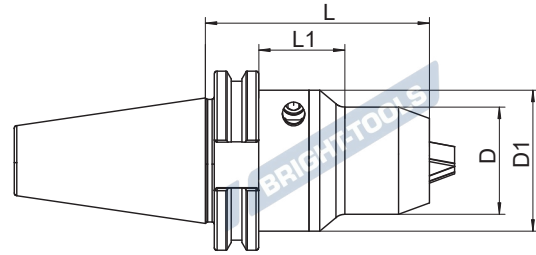

Size	D	D1	L	L1	Capacity
SK40-CPU10-80	38	50	80	28.9	1-10
SK40-CPU13-90	50	-	90	-	1-13
SK40-CPU16-90	50	-	90	-	1-16
SK50-CPU13-100	50	-	100	-	1-13
SK50-CPU16-100	50	-	100	-	1-16

SK

Quick Change Tapping Chuck with Length Compensation 弹性快换攻丝刀柄

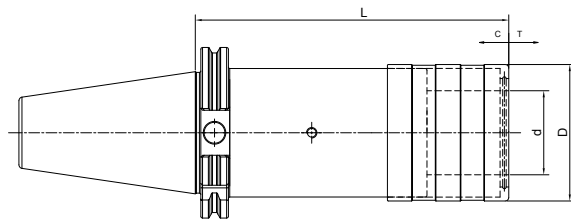

Size	D	d	L	T	C
SK30-TC312-65	36	19	65	7.5	7.5
SK30-TC820-99	54	31	99	12.5	12.5
SK40-TC312-59	36	19	59	7.5	7.5
SK40-TC820-97	54	31	97	12.5	12.5
SK40-TC1433-156	78	48	156	22	22
SK50-TC312-63	36	19	63	7.5	7.5
SK50-TC820-97	54	31	97	12.5	12.5
SK50-TC1433-140	78	48	140	22	22

Screw-in Milling Cutter Holder
锁牙刀柄, 锥柄型



A ↗ ≤0.005	RPM G6.3/15000	AD
---------------	-------------------	----

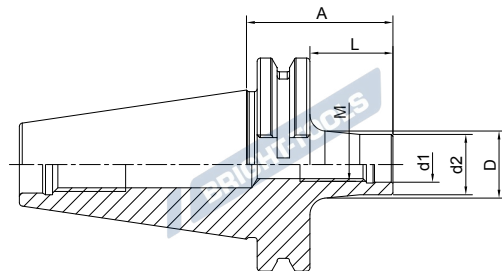

Size	M	d1	d2	A	L	D
SK40-SOM08-44 L=25	8	8.5	14.5	44	25	15
SK40-SOM08-69 L=50	8	8.5	14.5	69	50	23
SK40-SOM08-94 L=75	8	8.5	14.5	94	75	23
SK40-SOM08-119 L=100	8	8.5	14.5	119	100	25
SK40-SOM10-24 L=5	10	10.5	18	24	5	18
SK40-SOM10-44 L=25	10	10.5	18	44	25	20
SK40-SOM10-69 L=50	10	10.5	18	69	50	23
SK40-SOM10-94 L=75	10	10.5	18	94	75	28
SK40-SOM10-119 L=100	10	10.5	18	119	100	32
SK40-SOM10-169 L=150	10	10.5	18	169	150	36.5
SK40-SOM12-24 L=5	12	12.5	21	24	5	21
SK40-SOM12-44 L=25	12	12.5	21	44	25	24
SK40-SOM12-69 L=50	12	12.5	21	69	50	24
SK40-SOM12-94 L=75	12	12.5	21	94	75	31
SK40-SOM12-119 L=100	12	12.5	21	119	100	33
SK40-SOM12-144 L=125	12	12.5	21	144	125	36
SK40-SOM12-169 L=150	12	12.5	21	169	150	40
SK40-SOM16-24 L=5	16	17	29	24	5	29
SK40-SOM16-44 L=25	16	17	29	44	25	29
SK40-SOM16-69 L=50	16	17	29	69	50	34
SK40-SOM16-94 L=75	16	17	29	94	75	34
SK40-SOM16-119 L=100	16	17	29	119	100	36
SK40-SOM16-144 L=125	16	17	29	144	125	40
SK40-SOM16-169 L=150	16	17	29	169	150	42.5

SK



Screw-in Milling Cutter Holder

锁牙刀柄, 锥柄型



A ↗ ≤0.005	RPM G6.3/15000	 AD
---------------	-------------------	---

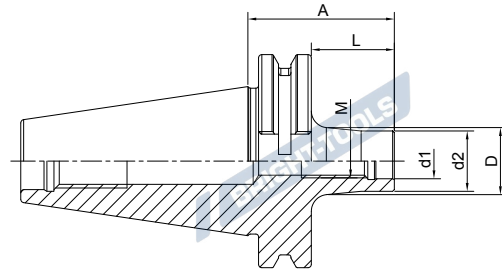

Size	M	d1	d2	A	L	D
SK50-SOM08-69 L=50	8	8.5	14.5	69	50	23
SK50-SOM08-119 L=100	8	8.5	14.5	119	100	25
SK50-SOM08-169 L=150	8	8.5	14.5	169	150	30
SK50-SOM10-69 L=50	10	10.5	18	69	50	23
SK50-SOM10-119 L=100	10	10.5	18	119	100	32
SK50-SOM10-169 L=150	10	10.5	18	169	150	36.5
SK50-SOM12-69 L=50	12	12.5	21	69	50	24
SK50-SOM12-119 L=100	12	12.5	21	119	100	33
SK50-SOM12-169 L=150	12	12.5	21	169	150	40
SK50-SOM16-69 L=50	16	17	29	69	50	34
SK50-SOM16-119 L=100	16	17	29	119	100	36
SK50-SOM16-169 L=150	16	17	29	169	150	42.5

SK

Screw-in Milling Cutter Holder 锁牙刀柄, 直柄型

A ↗ ≤0.005	RPM G6.3/15000	AD
---------------	-------------------	----

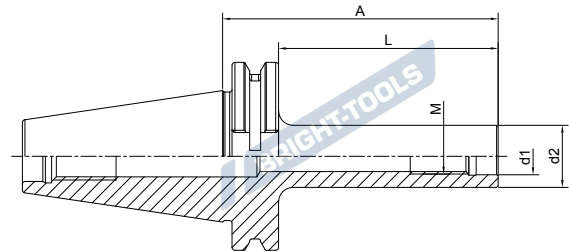

Size	M	d1	d2	A	L
SK40-M10-119 L=100	10	10.5	18	119	100
SK40-M10-169 L=150	10	10.5	18	169	150
SK40-M12-119 L=100	12	12.5	21	119	100
SK40-M12-144 L=125	12	12.5	21	144	125
SK40-M12-169 L=150	12	12.5	21	169	150
SK40-M16-119 L=100	16	17	29	119	100
SK40-M16-144 L=125	16	17	29	144	125
SK40-M16-169 L=150	16	17	29	169	150
SK50-M10-119 L=100	10	10.5	18	119	100
SK50-M10-169 L=150	10	10.5	18	169	150
SK50-M12-119 L=100	12	12.5	21	119	100
SK50-M12-169 L=150	12	12.5	21	169	150
SK50-M16-119 L=100	16	17	29	119	100
SK50-M16-169 L=150	16	17	29	169	150

SK



Runout Adjustable Flange Adapter 可调节精度法兰刀柄

A ↗ ≤0.002	RPM G2.5/25000	 AD
----------------------	--------------------------	---------------

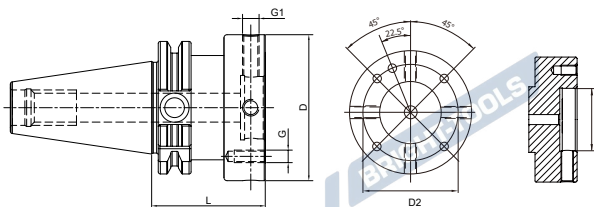

Size	D	D1	D2	L	G	G1
SK30-MOD060-050	60	30	44	50	M5	M8x1
SK30-MOD070-050	70	35	53	50	M6	M8x1
SK40-MOD060-050	60	30	44	50	M5	M8x1
SK40-MOD070-050	70	35	53	50	M6	M8x1
SK40-MOD080-055	80	40	63	55	M6	M8x1
SK40-MOD100-060	100	50	79	60	M8	M10x1
SK50-MOD060-050	60	30	44	50	M5	M8x1
SK50-MOD070-050	70	35	53	50	M6	M8x1
SK50-MOD080-050	80	40	63	50	M6	M8x1
SK50-MOD100-060	100	50	79	60	M8	M10x1
SK50-MOD117-060	117	60	96	60	M8	M10x1
SK50-MOD140-060	140	80	119	60	M10	M10x1

UM Adjustable Tool Holder UM 调零刀柄

A ↗ ≤0.003	RPM G2.5/25000	 AD
----------------------	--------------------------	---------------

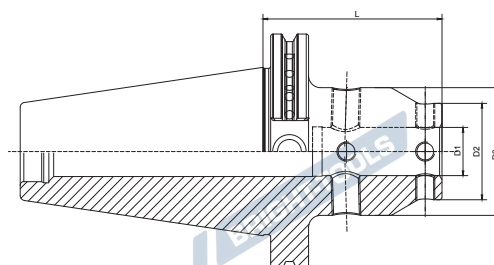

Size	D1	D2	D3	L
SK40-UM12-65	12	28	44.5	65
SK40-UM16-65	16	32	48	65
SK40-UM20-85	20	40	53	85
SK40-UM25-100	25	48	63	100
SK40-UM32-105	32	52	63	105
SK50-UM12-65	12	28	44.5	65
SK50-UM16-65	16	32	48	65
SK50-UM20-75	20	40	53	75
SK50-UM25-85	25	48	63	85
SK50-UM32-90	32	52	63	90

Boring Bar Blank 基础柄

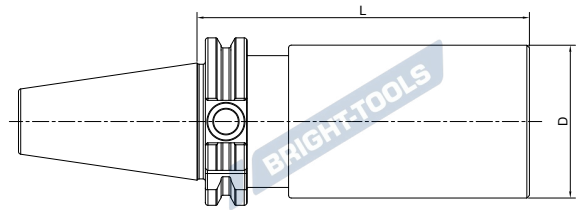

Size	D	L
SK30-D50-200	50	200
SK40-D50-200	50	200
SK40-D50-250	50	250
SK40-D63-250	63	250
SK50-D100-160	100	160
SK50-D100-250	100	250

Other sizes can be made by request.

SK

Test Arbor 主轴检测棒

A ↗
≤0.002

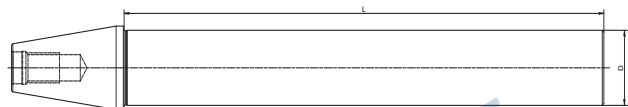

Size	D	L
SK30-32-250	32	250
SK40-40-300	40	300
SK50-50-300	50	300

Alignment Tool for ATC Arm

调整机械手用组合模具

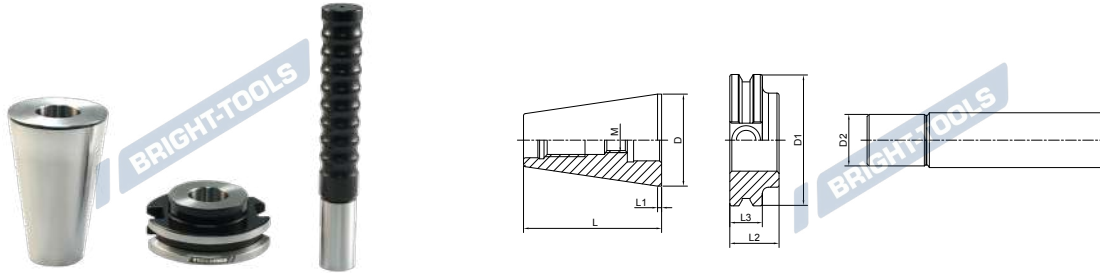

Size	D	D1	D2	L	L1	L2	L3	M
SK30-ATC-18D	31.75	50	18	51	3.2	20	15.9	M12
SK40-ATC-20D	44.45	63.55	20	71.6	3.2	25	15.9	M12
SK50-ATC-28D	69.85	97.5	28	104.95	3.2	35	15.9	M16

Usage:

- 1) Put the Taper to the machine Spindle
- 2) Install flange to the ATC arm
- 3) Insert Pin into the flange
- 4) Adjust ATC arm and make sure the pin front part into the flange completely.

使用方法:

- 1) 将锥度安装到机床主轴上
- 2) 将法兰安装到 ATC 臂上
- 3) 将销钉插入法兰中
- 4) 调整 ATC 臂并确保销钉前部完全进入法兰中。

Alignment Tool for ATC Arm

调整机械手用组合模具

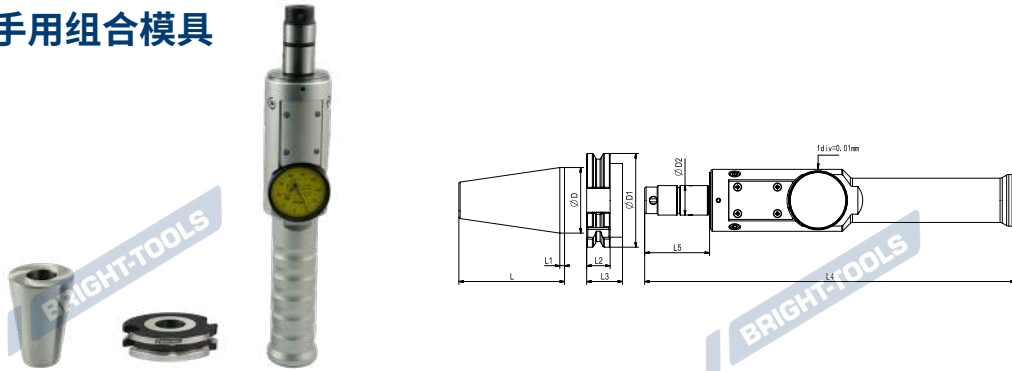

Size	D	D1	D2	L	L1	L2	L3	L4	L5
SK40-ATC20	44.45	63.55	20	71.6	3.2	15.9	24.3	251	44
SK50-ATC28	69.85	97.5	28	104.95	3.2	15.9	35.3	261	54

Usage:

1. Install the calibration taper to the machine spindle.
2. Install the calibration flange on the ATC machine.
3. Insert the calibration pin into the calibration flange.
4. Rotate the calibration pin to find the maximum and minimum positions of the pointer. value position of the pointer. This direction is the direction of eccentricity, and the amount of eccentricity is half of the difference.
5. Adjust the ATC manipulator and ensure that the front of the calibration pin is fully inserted into the flange.

使用方法

1. 将校正锥柄安装到机床主轴。
2. 将校正法兰安装在 ATC 机械手上。
3. 将校正销棒插入校正法兰。
4. 旋转校正销棒, 找到指针的最大值位置和最小值位置。该方向即偏心方向, 偏心量为差值的一半。
5. 调整 ATC 机械手并确保校正销棒前端完全插入法兰中。

BRIGHT-TOOLS

BRIGHT-TOOLS

TOOL HOLDERS ISO

BRIGHT-TOOLS

BRIGHT-TOOLS

BRIGHT-TOOLS

BRIGHT-TOOLS

BRIGHT-TOOLS

BRIGHT-TOOLS

ISO Taper Standard ISO 锥柄标准

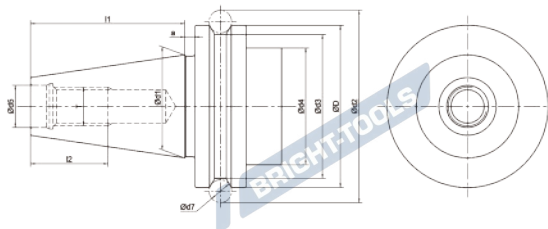
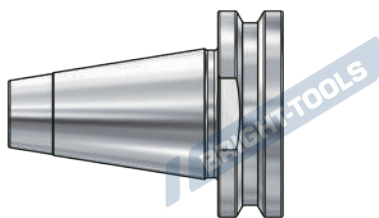

Size	D	d1	d2	d3	d4	d5	d7	l1	l2
ISO30	50	31.75	59.3	44.3	45	13	7	47.8	24
ISO40	63.55	44.45	72.3	56.25	50	17	7	68.4	32

Material: Alloyed case hardened steel
Surface Treatment: Blackening and Bright
Taper tolerance: <AT3
Hardness: HRC 56-60
Carbon depth: 0.8±0.2mm
Surface Roughness: Ra<0.2µm
Balancing: G2.5/25000
Cooling: AD

BRIGHT-TOOLS

BRIGHT-TOOLS

BRIGHT-TOOLS

BRIGHT-TOOLS

BRIGHT-TOOLS

BRIGHT-TOOLS

ER Collet Chuck without Drive Slots
ER 弹簧夹头刀柄

DIN6499	A ≤ 0.003	RPM G2.5/25000	AD
---------	----------------	----------------	----

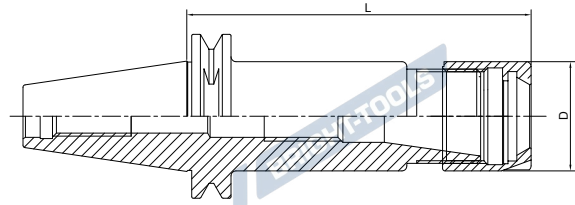

Size	D	L	Capacity
ISO10-ER11-25	19	25	1-7
ISO20-ER16-35	28	35	1-10
ISO20-ER20-35	34	35	1-13
ISO25-ER16-35	28	35	1-10
ISO25-ER20-35	34	35	1-13
ISO30-ER16-50	28	50	1-10
ISO30-ER20-50	34	50	1-13

ISO

ER Collet Chuck without Drive Slots
ER 弹簧夹头刀柄

DIN6499	A ≤ 0.003	RPM G2.5/25000	AD
---------	----------------	----------------	----

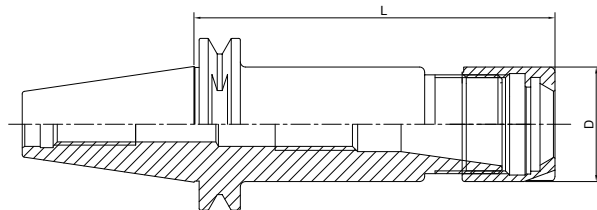

Size	D	L	Capacity
ISO20-ER16MS-35	22	35	1-10
ISO20-ER20MS-35	28	35	1-13
ISO25-ER16MS-35	22	35	1-10
ISO25-ER20MS-35	28	35	1-13
ISO25-ER25MS-35	35	35	2-16

BRIGHT-TOOLS

BRIGHT-TOOLS

ER Collet Chuck without Drive Slots

ER 弹簧夹头刀柄

DIN6499	A ≤ 0.003	RPM G2.5/25000	AD
---------	----------------	----------------	----

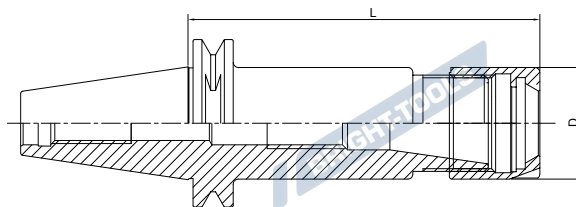

Size	D	L	Capacity
ISO25-ER25-35	42	35	2-16
ISO30-ER25-50	42	50	2-16
ISO30-ER32-50	50	50	2-20
ISO30-ER40-60	63	60	3-26

ISO

ER Collet Chuck without Drive Slots

ER 弹簧夹头刀柄

DIN6499	A ≤ 0.003	RPM G2.5/25000	AD
---------	----------------	----------------	----

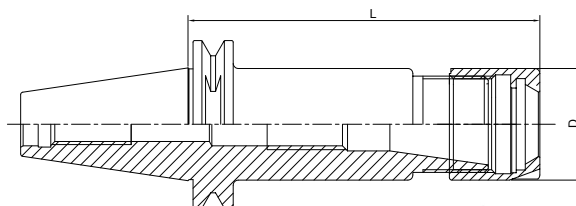

Size	D	L	Capacity
ISO10-ER11M-25	16	25	1-7
ISO20-ER20M-35	28	35	1-13
ISO25-ER20M-35	28	35	1-13
ISO30-ER25M-50	35	50	2-16